

WELCOME TO CLEARWATER

The essential ingredients to create an inspirational kitchen are functionality, great design and faithful reliability. Our company ideal is to combine all three of these elements to provide the perfect sink and tap for you.

With Clearwater Products you can tailor and fine tune your exact requirements by selecting from the wide choice of sink and tap types, designs and materials.

We have divided our sinks between material and installation types and our taps between function and styles so you can quickly navigate our brochure to discover the perfect combination for your cooking, cleaning and design aspirations.

Our staff have extensive knowledge and experience of the kitchen industry and we are always on hand to answer any questions you may have - without you having to run the gauntlet of the automated switchboard!

All our products are sold exclusively through our network of dealers.

Phone us now for your nearest retail outlet.



SINKS



CERAMIC INSET

Harmony	34-35
Jarla	40-41
Lydian Chef	30-31
Melody Pro	32-33
Opus	36-37
Sonnet	38-39



UNDERMOUNT

Avola	46-47
Metro	42-45



BRITISH CLASSICS

Belfast	49
Bredon	57
Buxton	61
Chiltern	55
Cotswold	59
Cumbria	58
Essex	52
Norfolk	51
Oxford	50
Suffolk	56
Tudor	53
Wessex	60
Windsor	54

CONTEMPORARY

Ashton	66
Heritage	65
Legacy	62
Vintage	63-64
Utility & Laundry	66-67



GRANITE Quarex®

Capri	16-17
Gemini	12-13
Kameo Smart	10-11
Nova	14-15



GRANITE Quarsil®

Carina	20-21
Rio	24-25
Siena	26-27
Tivoli	22-23



CAST IRON

Saxon	69-71
-------	--------------

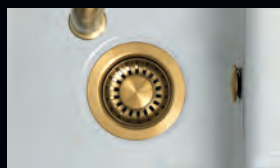

ACCESSORIES

Cleaning Products	214
Filter Cartridges	128
Wastes & Plumbing Kits	126-128
Waste Sorter Bins	129



STAINLESS STEEL INSET

Arco	97
Arco Mini	97
Ava	76
Bar 47	96
Bella	96
Bolero	77
Contract	98-99
Cresta	86
Deep Blue	80
Indio	78-79
Kudos	81
Monza	85
Oboe	97
Okio	82-83
Pio Bar	96
Solar	87
Starline	75
Urban	92-93
Urban Smart	94-95
Verdi	74
Viva	84
Xeron	88-89
Zenith	90-91

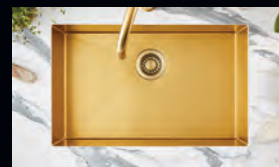

UNDERMOUNT

Jazz	102-103
Salsa	104-105
Salsa PVD	120-121
Stark	110-111
Stark Smart	112-113
Stereo	108-109
Tango	106-107
Volta	114-115
Volta PVD	116-117
Volta PVD Nano	118-119
Vortex	100-101

APRON FRONT

Infinity Smart	124-125
Belfast	122-123

TAPS



TWIST & SPRAY

Davina	170
Rococo	168
Savita	164
Siren	164
Topaz	166-167
Tutti	169
Zodiac	165



STANDARD

Auriga	184
Alzira	171
Auva	178
Corona	182
Cosmo	182
Cherika	183
Creta	185
Dorman	185
Elara	180
Jovian	179
Juno	172
Levant	174
Loreto	178
Miram	181
Morpho	176-177
Pioneer	173
Pulsar	182
Rossi	184
Sheratan	183
Studio	185
Taku	175
Ultra	185
Vegas	183
Venue (Contract)	99
Vitro	184



PULL-OUT

Auriga	195
Creta	193
Elmira	194
Emporia	194
Karuma	190
Kira	189
Larissa	187
Levant	186
Pioneer	192
Porrima	193
Santor	191
Topaz	188



PROFESSIONAL

Alasia Pro	196-197
Galaxy	198
Jovian	201
Meridian	200
Triton	199
Tutti Pro	199

STAINLESS STEEL

Calypso	205
Galaxy	204
Mercury	204
Sirius	203
Titania	202
Mira Siphon	204

PULL-OUT SPRAY

Modern	206
Traditional	207

SENSOR TAPS

Amelio	162
Azia	163
Galex Motion	160-161



KETTLE TAPS

Hotshot	138-139
Longdon 4	140-141
Magus 3	134-135
Magus 4	136-137



FILTER TAPS

Alpha	156
Aquarius S/S	158
Bellatrix	150-151
Galex	148-149
Hydra	157
Malin	157
Mariner	144-145
Mira (S/S)	158
Neso	156
Pure Chiller 100	159
Rosetta	146
Toledo	147
Tri-Spa	152-155
Zuben S/S	159



TRADITIONAL TAPS

Alrisha	213
Baroc	210
Baroc Bridge	210
Coriolis	213
Cottage	211
Cottage Bridge	211
Dephini	212
Dephini Bridge	212
Elegance Twist & Spray	209
Elegance Bridge T&S	209
Equinox	208
Regent	213

SINKS

CHOICES



INSET

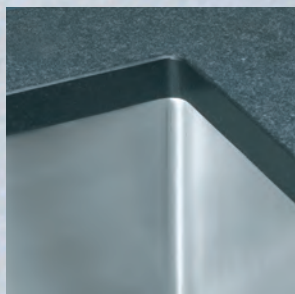

UNDERMOUNT



APRON FRONT



SINGLE BOWLS



INTEGRATED DRAINERS



MULTI BOWLS



BUTLER

MATERIALS

STAINLESS STEEL

- Hygienic
- Easy to Clean
- Resistant to High Heat
- Stain Resistant
- Corrosion Resistant
- Premium Grade Steel

GRANITE

- Hygienic
- Easy to Clean
- Uniform Structure
- Stain Resistant
- Corrosion Resistant
- Scratch Resistant
- Resistant to High Heat
- High Content of Natural Material
- Impact Resistant
- Thermal Shock Resistant
- Surface Abrasion Resistant

CERAMIC & CAST IRON

- Hygienic
- Easy to Clean
- Resistant to High Heat
- Stain Resistant
- Chemical Resistant
- Durable and Long Lasting



INSTALLATION

INSET Sink is mounted into the worktop, suitable for all types of worktops.

UNDERMOUNT Sink is fitted to the underside of the worktop, only suitable for solid surface worktops.

APRON FRONT Sink is fitted directly onto the cabinet, only suitable for solid surface worktops.

BOWLS

SOFT RADIUS
Easy to clean traditional styling

SHARP RADIUS
Slick contemporary styling offering many price levels and steel thickness options

SIZING

The sizing is based on ensuring the cabinet is large enough to fit the bowl or bowls.

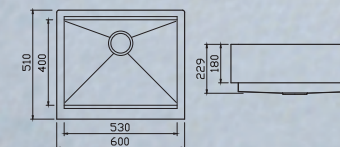

QUAREX®

The latest generation of Quarex® has been achieved over many years of development and this latest compound which includes 80% quartz has been enriched with silver ions. Silver nano-particles form a protective coating on the surface of the granite with the anti-microbial properties reducing the growth of bacteria and microbes by as much as 98%.

HYGIENIC SURFACE

The advanced anti-bac surface ensures optimum safety when handling food and the fine structure of Quarex® offers dirt-repellent properties.

RESILIENT SURFACE

The robust qualities of Quarex® ensure high resistance to the rigours of the kitchen environment including a high ability to withstand scratches, impacts and high temperatures.



Dirt-repellent effect
The dirt simply runs off.



Odour-free
Leaves the surface free of smells.



Heat-resistant
Not temperature sensitive.



Food-safe
Absolutely safe material.



Hygienic Surface



Made to last
Extremely durable.



Stain-resistant
Food stains cannot stick.



Impact-resistant
Tough and resistant material.

- Blizzard
- Fossil
- Steel
- Slate
- Jet
- Ash

ICONS EXPLAINED

Installation



Inset Undermount

Handing



Reversible

Other Details



Waste Included



CLEARWATER GRANITE SINKS HAVE A LIFETIME WARRANTY



Clearwater Granite Care Set
Ref. CLEG100 £40
Comprising of - an alcohol based cleaner a brightener and a nano sponge

Matching Wastes Available

Coloured wastes available to match your choice of tap - see following pages.





Kameo D150L in Blizzard shown with Morpho Brushed Brass tap with flex and stay spout - see page 176-177

Accessory Included



Ref. WBD433
Wooden Chopping Board

Optional Accessories



Ref. COL415
Stainless Steel Colander £120
Fits main bowl only



Ref. TR415
Stainless Steel Tray £46
Fits main bowl only



Ref. DR3000
Stainless Steel
Draining Mat
(square bar) £59



Kameo D150L in Blizzard shown with Stainless Steel Draining Mat

BLIZZARD (BL) ASH (AH) FOSSIL (FL) STEEL (ST) SLATE (SL) JET (JT)

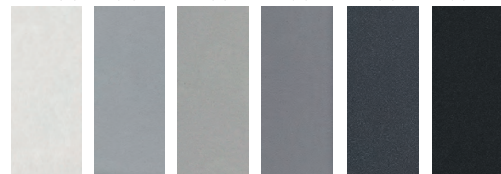

Add colour suffix when ordering
See page 9 for larger colour samples and to learn about the amazing properties of Quarex®.



Kameo D100L in Slate shown with Pioneer Pull-out tap in Brushed Nickel - see page 192

SINKS GRANITE INSET

Standard Waste Kits



Brushed Steel
supplied as standard

Optional Coloured Wastes



Artisan Brass
W900AB £69
W90AB £53



Artisan Brass
W60AB £43

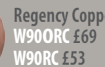

Regency Copper
W900RC £69
W90RC £53



Regency Copper
W60RC £43



Matt Black
W900MB £69
W90MB £53



Matt Black
W60MB £37

1.0 Bowl = 1 x W900**

1.5 Bowl = 1 x W900** + 1 x W60**



Kameo Smart Single bowl and drainer
Ref. KAM D100L £299

Overall size: 1000/500 mm
Bowl size: 480/440/200 mm
Cutout size: 980/480 mm
Minimum cabinet size: 600 mm
Standard waste kit included

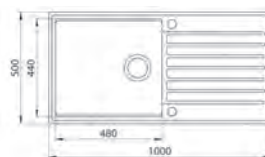

Kameo Smart 1.5 bowl and drainer
Ref. KAM D150L £329

Overall size: 1000/500 mm
Bowl size: 400/440/200 mm
Half bowl: 120/320/120 mm
Cutout size: 980/480 mm
Minimum cabinet size: 600 mm
Standard waste kit included

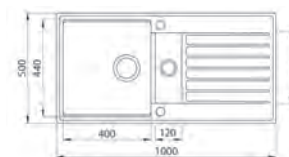

KAMEO SMART QUAREX®



The Kameo sinks feature a 'Smart Ledge' that is designed into each bowl enabling a set of four catering accessories to be employed for chopping, straining and draining. These sinks combine fresh contemporary styling with huge capacity bowls that will swallow up a multitude of jobs.

The D150 principal bowl is noteworthy for its unrivalled generous width of 400mm. This has been achieved by minimizing the strainer bowl with the use of a compact 60mm strainer waste and the extra space gained has been allocated to the main bowl where it is needed most.



Gemini D100S in Blizzard



Gemini D150S in Jet shown with Magus 3 kettle tap in Chrome - see pages 134-135

SINKS GRANITE INSET

Standard Wastes

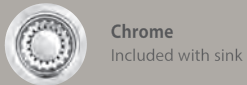

Optional Presto Automatic Waste Kits

For full details about the Presto Automatic Waste see page 127



Gemini GEM D100S = WP10**
Gemini GEM D150S = WP20**



Gemini Single bowl and drainer
Ref. GEM D100S £289
Overall size: 780/500 mm
Bowl size: 450/410/200 mm
Cutout size: 760/480 mm
Minimum cabinet size: 600 mm
Standard waste kit included

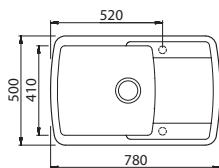

Gemini 1.5 bowl and drainer
Ref. GEM D150S £349
Overall size: 960/500 mm
Bowl size: 360/437/200 mm
Half bowl: 160/345/120 mm
Cutout size: 940/480 mm
Minimum cabinet size: 600 mm
Standard waste kit included

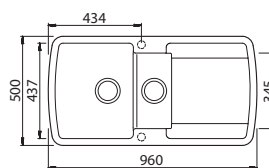

BLIZZARD (BL) ASH (AH) JET (JT)

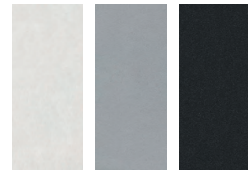

Add colour suffix when ordering
See page 9 for larger colour samples and to learn about the amazing properties of Quarex®.

GEMINI QUAREX®



The **Gemini** steps away from the fashion for minimalist symmetry and instead embraces a soft curved design. The bowl sizes are larger than most sinks and the drainer is particularly smart.

The Gemini would be an ideal choice with Shaker style kitchens. Available in three Quarex® colours.



Magus 3 kettle tap in Chrome - see pages 134-135



Icons Explained see page 9.



Nova N330 in Jet shown with Amelio Sensor tap in Matt Black - see page 162



Nova N200 in Slate shown with Pioneer tap in Brushed Brass - see page 173

NOVA QUAREX®



The **Nova** collection of sinks offer a selection of bowl sizes that will suit all kitchen demands, from the Compact N330 secondary/entertainment sink to the huge N780 with capacious dimensions that will swallow up the largest of oven trays and pans. The soft radius corners of the Nova make it an ideal choice for both modern and retro kitchen designs. They can be installed as undermount or inset.

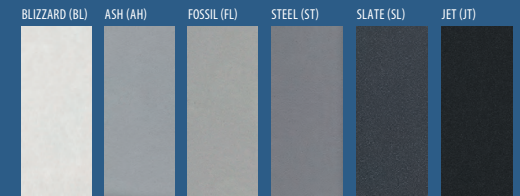

Add colour suffix when ordering
See page 9 for larger colour samples and to learn about the amazing properties of Quarex®.



Nova Single bowl
Ref. NOV N330 £279
Overall size: 380/380 mm
Bowl size: 330/330/190 mm
Cutout size: Template Available
Minimum cabinet size: 450 mm
Standard waste kit included

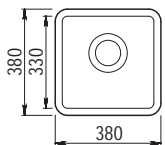

Nova Single bowl
Ref. NOV N370 £299
Overall size: 420/460 mm
Bowl size: 370/410/200 mm
Cutout size: Template Available
Minimum cabinet size: 450 mm
Standard waste kit included

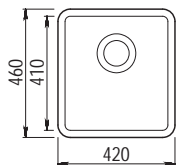

Nova Single bowl
Ref. NOV N535 £339
Overall size: 585/460 mm
Bowl size: 535/410/210 mm
Cutout size: Template Available
Minimum cabinet size: 800 mm
Standard waste kit included

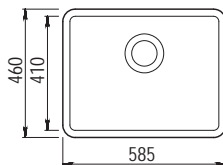

Nova Single bowl
Ref. NOV N780 £439
Overall size: 810/480 mm
Bowl size: 760/430/230 mm
Cutout size: Template Available
Minimum cabinet size: 1000 mm
Standard waste kit included

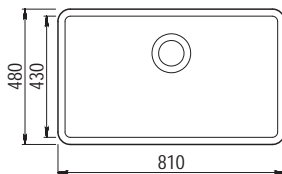

Nova 1.5 bowl
Ref. NOV N150 £359
Right hand main bowl only
Bowl size: 349/441/195 mm
Half bowl: 163/361/160 mm
Cutout size: Template Available
Minimum cabinet size: 600 mm
Standard waste kit included

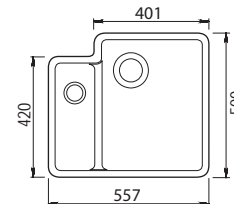

Nova Double bowl
Ref. NOV N200 £479
Overall size: 810/480 mm
Bowl sizes: 370/430/230 mm
Cutout size: Template Available
Minimum cabinet size: 1000 mm
Standard waste kit included

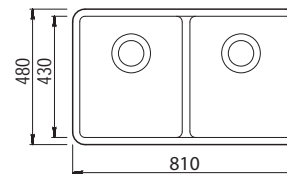

Standard Wastes



Stainless
Included with sink

Optional Coloured Wastes

1.0 Bowl = 1 x W900**
2.0 Bowl = 1 x W90** + 1 x W90**
1.5 Bowl = 1 x W90** + 1 x W60**
60mm waste is not available in Gold



Gold
W900G £69
W90G £53



Regency Copper
W900RC £69
W90RC £53
W60RC £43



Artisan Brass
W900AB £69
W90AB £53
W60AB £43



Matt Black
W900MB £69
W90MB £53
W60MB £37



Capri N505 in Ash



Capri N175 in Slate shown with Zuben Stainless Steel Filter tap - see page 159



Capri N690 in Blizzard

BLIZZARD (BL) ASH (AH) FOSSIL (FL) STEEL (ST) SLATE (SL) JET (JT)

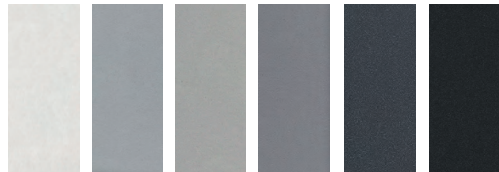

Add colour suffix when ordering
See page 9 for larger colour samples and to learn about the amazing properties of Quarex®.

CAPRI QUAREX®



The **Capri** collection comprise three futuristic styled bowls featuring a unique sloping rear ledge housing the overflow outlet. This unusual arrangement looks very sophisticated when combined with narrow radius bowls which emphasize the Capri's crisp lines. The Capri's Ledge Overflow maximizes the depth of water in the bowl before the overflow is employed. The Capri can be installed as an Undermount or Inset.



Stainless Steel Square wastes are supplied with the Capri in keeping with the Capri's ultramodern aesthetics.



Capri Single bowl
Ref. CAP N505 £339
Overall size: 555/455 mm
Bowl size: 505/405/200 mm
Cutout size: Template Available
Minimum cabinet size: 600 mm
Waste kit included

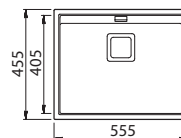

Capri Single bowl
Ref. CAP N690 £399
Overall size: 740/455 mm
Bowl size: 690/405/200 mm
Cutout size: Template Available
Minimum cabinet size: 800 mm
Waste kit included

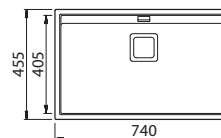

Capri 1.75 bowl
Ref. CAP N175 £449
Overall size: 650/455 mm
Bowl size: 375/405/200 mm
Half bowl: 220/405/180 mm
Cutout size: Template Available
Minimum cabinet size: 800 mm
Waste kit included

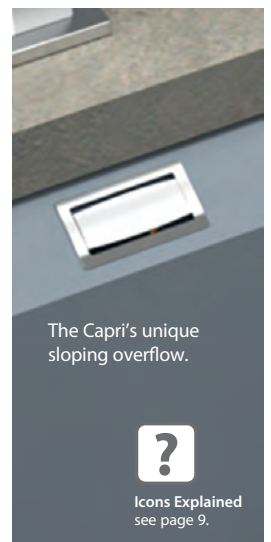
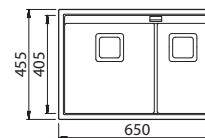

The Capri's unique sloping overflow.



Icons Explained see page 9.

QUARSIL®

QUARSIL®

The new generation of Quarsil® has been developed over 30 years and now features substantially improved properties. It is now even easier to clean and has a new intensity of colour.

HYGIENIC SURFACE

The advanced anti-bac surface quality of Quarsil® ensures optimum safety when handling food.

DIRT-REPELLENT EFFECT

The material's fine structure means dirt that could be a breeding ground for bacteria finds it impossible to stick to the surface.

PRODUCT BENEFITS

QUARSIL® Granite sinks are up to 80% natural quartz sand and specially developed for the demands of the kitchen, and the rigours of everyday use.



Dirt-repellent effect
The dirt simply runs off.



Odour-free
Leaves the surface free of smells.



Heat-resistant
Not temperature sensitive.



Food-safe
Absolutely safe material.



Hygienic Surface



Made to last
Extremely durable.



Stain-resistant
Food stains cannot stick.



Impact-resistant
Tough and resistant material.



Clearwater Granite Care Set
Ref. CLEG100 £40
Comprising of an alcohol based cleaner, a brightener and a nano sponge

QUARSIL® COLOURS

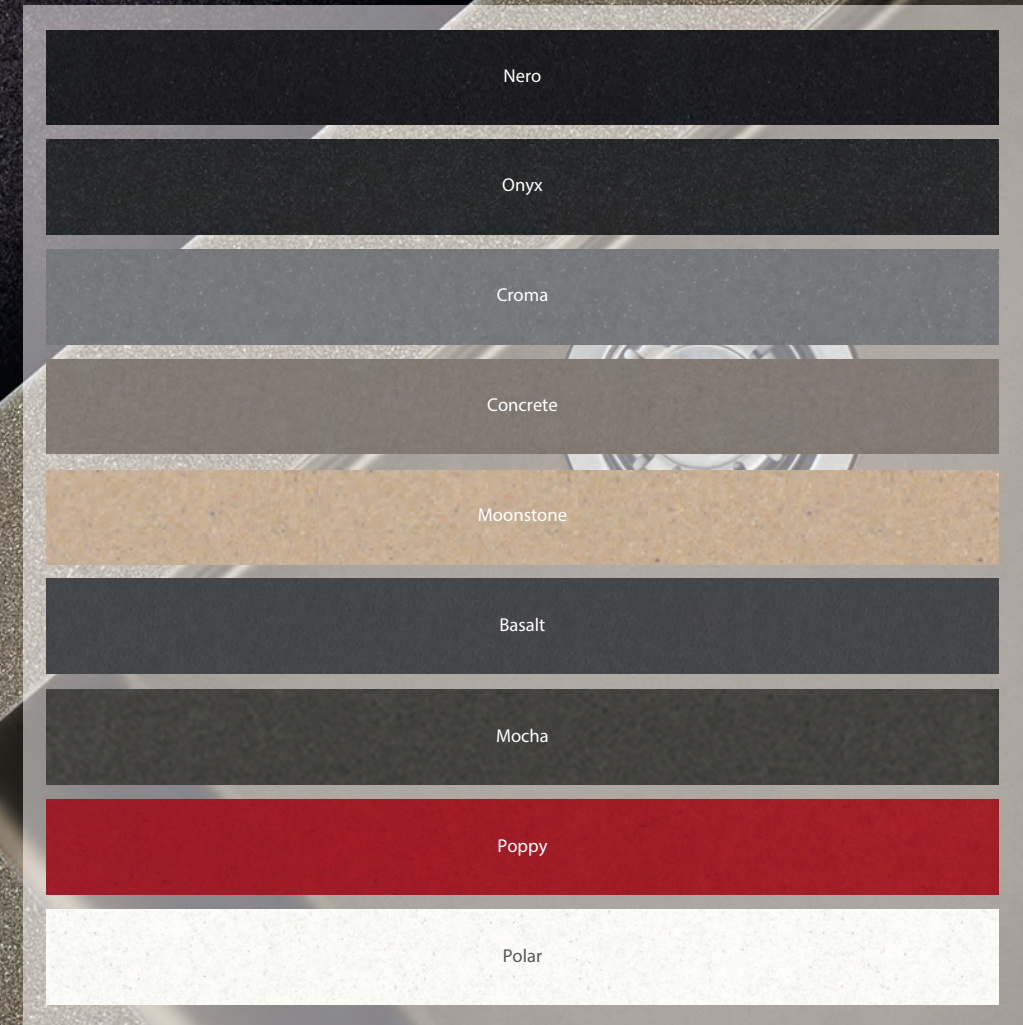

ICONS EXPLAINED

Installation



Inset



Undermount



Reversible



Waste Included

Handing

Other Details



CLEARWATER GRANITE SINKS HAVE A LIFETIME WARRANTY

Matching Wastes Available

Coloured wastes available to match your choice of tap - see following pages.



Artisan Brass



Regency Copper



Gold



Matt Black

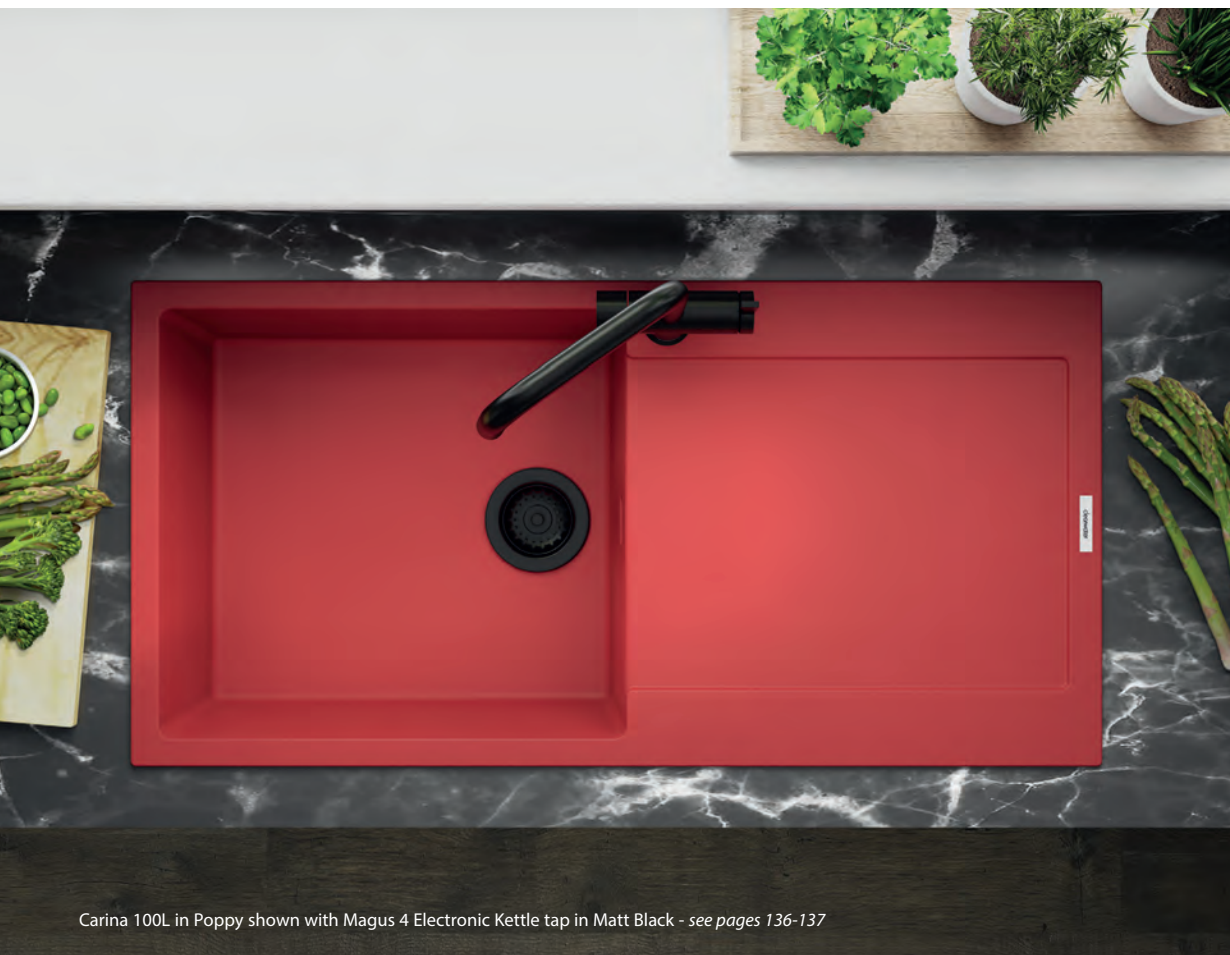

Carina 100L in Poppy shown with Magus 4 Electronic Kettle tap in Matt Black - see pages 136-137



Carina 150 in Croma shown with Pioneer Pull-out tap in Matt Black - see page 192



Carina Single bowl and drainer
Ref. CAR D100S £360
 Overall size: 860/500 mm
 Bowl size: 347/440/200 mm
 Cutout size: 840/480 mm
 Minimum cabinet size: 450 mm
 Standard waste kit included

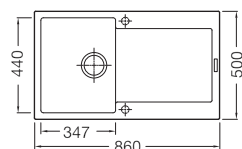

Carina Large bowl and drainer
Ref. CAR D100L £370
 Overall size: 1000/500 mm
 Bowl size: 480/440/200 mm
 Cutout size: 980/480 mm
 Minimum cabinet size: 600 mm
 Standard waste kit included

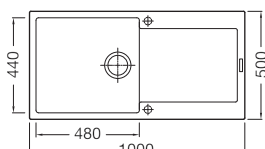

Carina 1.5 bowl and drainer
Ref. CAR D150 £370
 Overall size: 1000/500 mm
 Bowl size: 345/440/200 mm
 Half bowl: 155/295/146 mm
 Cutout size: 980/480 mm
 Minimum cabinet size: 600 mm
 Standard waste kit included

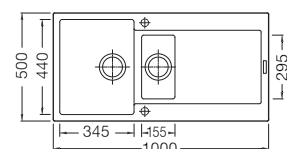

CARINA QUARSIL®



The **Carina's** smooth drainer and crisp corners offer chic sophistication. The capacious single bowl model is ideal for catering size pans and the popular 1.5 bowl model offers multi-task possibilities.

Available in nine amazing Quarsil® colours including a zingy red for that extra extravagance.

Optional Accessories



Ref. COL107
 Colander (Small) £70
 Fits half bowl



Ref. COL108
 Colander £80
 Spans main bowl



Magus 4 Electronic kettle tap in Matt Black - see pages 136-137

SINKS GRANITE INSET

Add colour suffix when ordering
 See page 19 for larger colour samples and to learn about the amazing properties of Quarsil®.

POLAR (PO) ONYX (ON) MOONSTONE (MS) NERO (NE) CROMA (CR) CONCRETE (CN) POPPY (PP) BASALT (BA) MOCHA (MC)

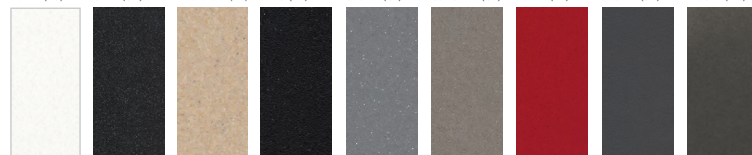

Strainer Wastes



Stainless supplied as standard

Optional Strainer Wastes



Artisan Brass W900AB £69 W90AB £53



Regency Copper W900RC £69 W90RC £53



Gold W900G £69 W90G £53



Matt Black W900MB £69 W90MB £53

1.0 Bowl = 1 x W900** 1.5 Bowl = 1 x W900** + 1 x W90**



Tivoli 150 in Cromia shown with Juno tap in Matt Black- see page 172



Tivoli Single bowl and drainer
Ref. TIV D100S £289
 Overall size: 860/500 mm
 Bowl size: 347/430/200 mm
 Cutout size: 840/480 mm
 Minimum cabinet size: 450 mm
 Standard waste kit included

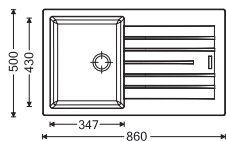

Tivoli Large bowl and drainer
Ref. TIV D100L £299
 Overall size: 1000/500 mm
 Bowl size: 480/430/200 mm
 Cutout size: 980/480 mm
 Minimum cabinet size: 600 mm
 Standard waste kit included

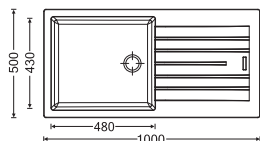

Tivoli 1.5 bowl and drainer
Ref. TIV D150 £299
 Overall size: 1000/500 mm
 Bowl size: 345/430/200 mm
 Half bowl: 155/340/146 mm
 Cutout size: 980/480 mm
 Minimum cabinet size: 600 mm
 Standard waste kit included

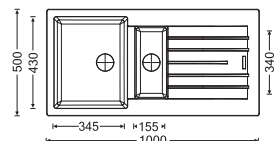

Tivoli 100L in Nero shown with Juno tap in Brushed Brass - see page 172

TIVOLI QUARSIL®



The economically priced **Tivoli** is offered in three configurations, so hopefully at least one of the models will be the perfect fit. The ultra-modern design is emphasised by the subtly graduated draining grooves and crisp radius corners and is available in nine fabulous Quarsil® colours. Don't forget to consider including accessories with your sink to add extra versatility.

Optional Accessories

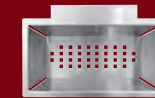

Ref. COL106
 Colander **£70**
 Fits half bowl



Ref. COL108
 Colander **£80**
 Spans main bowl

Strainer Wastes



Stainless
 supplied as
 standard

Optional Strainer Wastes



Regency Copper
 W90ORC **£69**
 W90RC **£53**



Artisan Brass
 W90OAB **£69**
 W90AB **£53**



Gold
 W90OG **£69**
 W90G **£53**



Matt Black
 W90OMB **£69**
 W90MB **£53**

1.0 Bowl = 1 x W900** 1.5 Bowl = 1 x W900** + 1 x W90**



Juno tap in Brushed Brass - see page 172

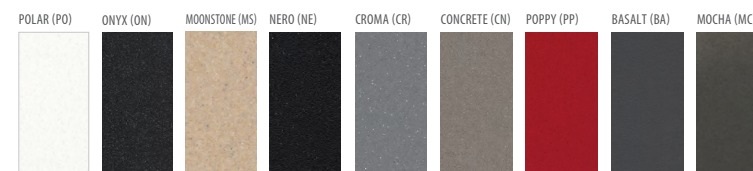

Add colour suffix when ordering

See page 19 for larger colour samples and to learn about the amazing properties of Quarsil®.



Icons Explained see page 19.



Rio 150 in Basalt shown with Azia Sensor tap in Matt Black - see page 163

Strainer Wastes

 **Stainless**
supplied as standard

Optional Strainer Wastes

 **Artisan Brass**
W900AB £69
W90AB £53

 **Regency Copper**
W900RC £69
W90RC £53

 **Gold**
W900G £69
W90G £53

 **Matt Black**
W900MB £69
W90MB £53

1.0 Bowl = 1 x W900**
1.5 Bowl = 1 x W900** + 1 x W90**

Rio 100L in Polar shown with Amelio Sensor tap in Matt Black - see page 162



Rio Large bowl and drainer
Ref. RIO D100L £299
Overall size: 1000/500 mm
Bowl size: 480/430/220 mm
Cut-out size: 980/480 mm
Minimum cabinet size: 600 mm
Standard waste kit included

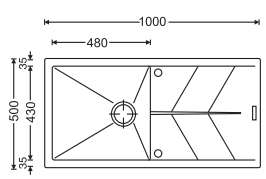

Rio 1.5 bowl and drainer
Ref. RIO D150 £299
Overall size: 1000/500 mm
Bowl size: 347/430/210 mm
Half bowl: 145/285/142 mm
Cut-out size: 980/480 mm
Minimum cabinet size: 600 mm
Standard waste kit included

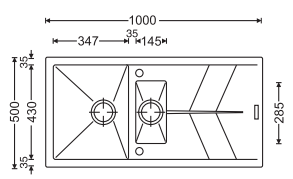

RIO
QUARSIL®



The **Rio** is an ultra-modern design with a trendy chevron drainer pattern. Both models boast extra deep bowls with draining lines shaped in the bowl base that promote rapid draining. We have offered nine fantastic Quarsil® colours for this popular sink so colour theming with your kitchen should be a breeze.

Optional Accessories

Ref. COL108
Colander £80
Spans main bowl

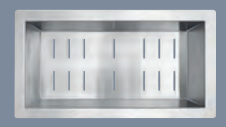

Azia Sensor tap in Matt Black - see page 163

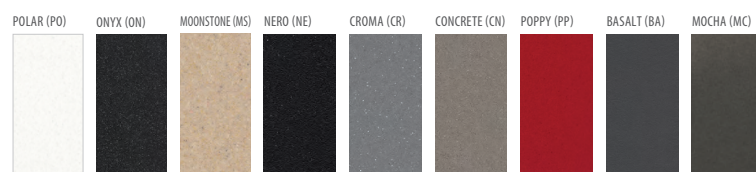

Add colour suffix when ordering
See page 19 for larger colour samples and to learn about the amazing properties of Quarsil®.

 **Icons Explained**
see page 19.



Siena 1.5 in Croma shown with Pioneer tap in Chrome- see page 173



Siena single bowls come in three size options, nine Quarsil® colours to suit most individual requirements and can be installed as undermount or inset. The fine radius corners add to the Siena's cool styling which can be made super cool by choosing a coordinating tap and waste in trend-setting PVD and black finishes.

- The purist's first choice to attain the ultimate minimalist effect
- Easy wipe-down surfaces with no raised edges
- Installation in solid surface worktops only – wood, stone, granite, synthetic

Siena 500 in Polar shown with Amelio Sensor tap in Brushed Brass- see page 162



Siena 1.5 in Onyx shown as inset

SIENA QUARSIL®



The Siena 150 ticks a lot of the boxes on a kitchen designer's wish list; cool contemporary design, sharp radius corners, generous bowl dimensions, and fits within a 60cm cabinet - a perfect solution when space is an issue. Siena bowls can be installed as undermount or inset.

This versatile sink can be fitted as left or right hand main bowl. Added to this, it boasts the widest colour palette available today.



Siena 1.5 bowl (Reversible)
Ref. SIE N150 £342

Overall size: 555/460 mm
Bowl size: 335/400/200 mm
Half bowl: 155/400/140 mm
Cutout size: Template Available
Minimum cabinet size: 600 mm
Standard waste kit included

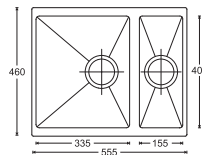

Siena Single bowl
Ref. SIE N340 £301

Overall size: 370/460 mm
Bowl size: 340/400/200 mm
Cutout size: Template Available
Minimum cabinet size: 450 mm
Standard waste kit included

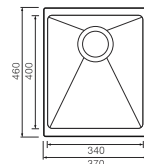

Siena Single bowl
Ref. SIE N400 £307

Overall size: 430/460 mm
Bowl size: 400/400/200 mm
Cutout size: Template Available
Minimum cabinet size: 500 mm
Standard waste kit included

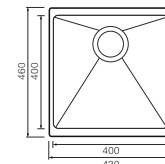

Siena Single bowl
Ref. SIE N500 £314

Overall size: 530/460 mm
Bowl size: 500/400/200 mm
Cutout size: Template Available
Minimum cabinet size: 600 mm
Standard waste kit included

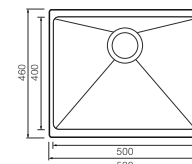

Amelio Sensor tap in Brushed Brass - see page 162

Strainer Wastes

Optional Strainer Wastes

1.0 Bowl = 1 x W900** 1.5 Bowl = 1 x W900** + 1 x W90**



Stainless supplied as standard



Artisan Brass
W900AB £69
W90AB £53



Regency Copper
W900RC £69
W90RC £53



Gold
W900G £69
W90G £53



Matt Black
W900MB £69
W90MB £53

POLAR (PO) ONYX (ON) MOONSTONE (MS) NERO (NE) CROMA (CR) CONCRETE (CN) POPPY (PP) BASALT (BA) MOCHA (MC)



Add colour suffix when ordering
See page 19 for larger colour samples and to learn about the amazing properties of Quarsil®.





Icons Explained see page 19.



Ceramic Sinks
Inset, Undermount & Butler

LIFE TIME WARRANTY

ALL THOMAS DENBY & CLEARWATER CERAMIC SINKS HAVE A LIFETIME WARRANTY

 <p>Inset</p> <p>This installation requires the sink to be mounted into the worktop from the top.</p> <p>This installation type is suitable for all types of worktop including laminated chipboard.</p>	 <p>Undermount</p> <p>This installation requires the sink to be fitted to the worktop from the underside.</p> <p>This installation is only suitable for solid surface worktops such as Granite, Marble or Wood.</p>	 <p>Butler</p> <p>In this installation the sink is fitted directly on to a cabinet with its front fascia exposed.</p> <p>This type of installation is only suitable for solid surface worktops such as Granite, Marble or Wood.</p>
---	---	---

Icons Explained

<p>Installation</p> <p>Inset (Flat) Undermount Butler</p>	<p>Handing</p> <p>Left & Right Versions Reversible</p>	<p>Other Details</p> <p>Waste Included Pop-Up Waste Included</p>	<p>Nano - Tech</p> <p>Is the process of applying an ultra thin surface layer which gives the product a mechanically flat surface making it -</p> <ul style="list-style-type: none"> Dirt Repellent & Hygienic Hydrophobic Chemical Resistance Ultraviolet Resistance Reduces grease and finger marks <p>Used on the following Ceramic sinks - Lydian Chef, Melody Pro, Harmony and Opus.</p>
--	---	---	--

PRODUCT BENEFITS

Heat Resistant: Ceramic is heat resistant to 1200° centigrade - this means pots from the stove and casserole dishes straight from the oven can safely rest on a ceramic sink.

Hygienic: Totally non-porous, the ultra smooth surface is the most hygienic material for sinks and the easiest to keep clean.

Chemical Resistant: Resistant to all household chemicals including neat bleach.

Extreme Hardness: Extremely resistant to impact, the surface is so hard cutlery won't scratch the glazed surface through normal use.

 <p>Dirt-repellent effect The dirt simply runs off.</p>	 <p>Odour-free Leaves the surface free of smells.</p>	 <p>Heat-proof Not temperature sensitive.</p>	 <p>Food-safe Absolutely safe material.</p>
 <p>Hygienic Surface</p>	 <p>Made to last Extremely durable.</p>	 <p>Stain-resistant Food stains cannot stick.</p>	 <p>Impact-resistant Tough and resistant material.</p>

Tap Holes

Chargeable knock-out service available on request

The dimensions of ceramic sinks may vary by +/- 2% from those given due to natural shrinkage and expansion during the manufacturing process.



Clearwater Cast Iron and Ceramic Cleaner
Ref. CLEC200 £14
Removes stubborn metal marks and stains with little effort

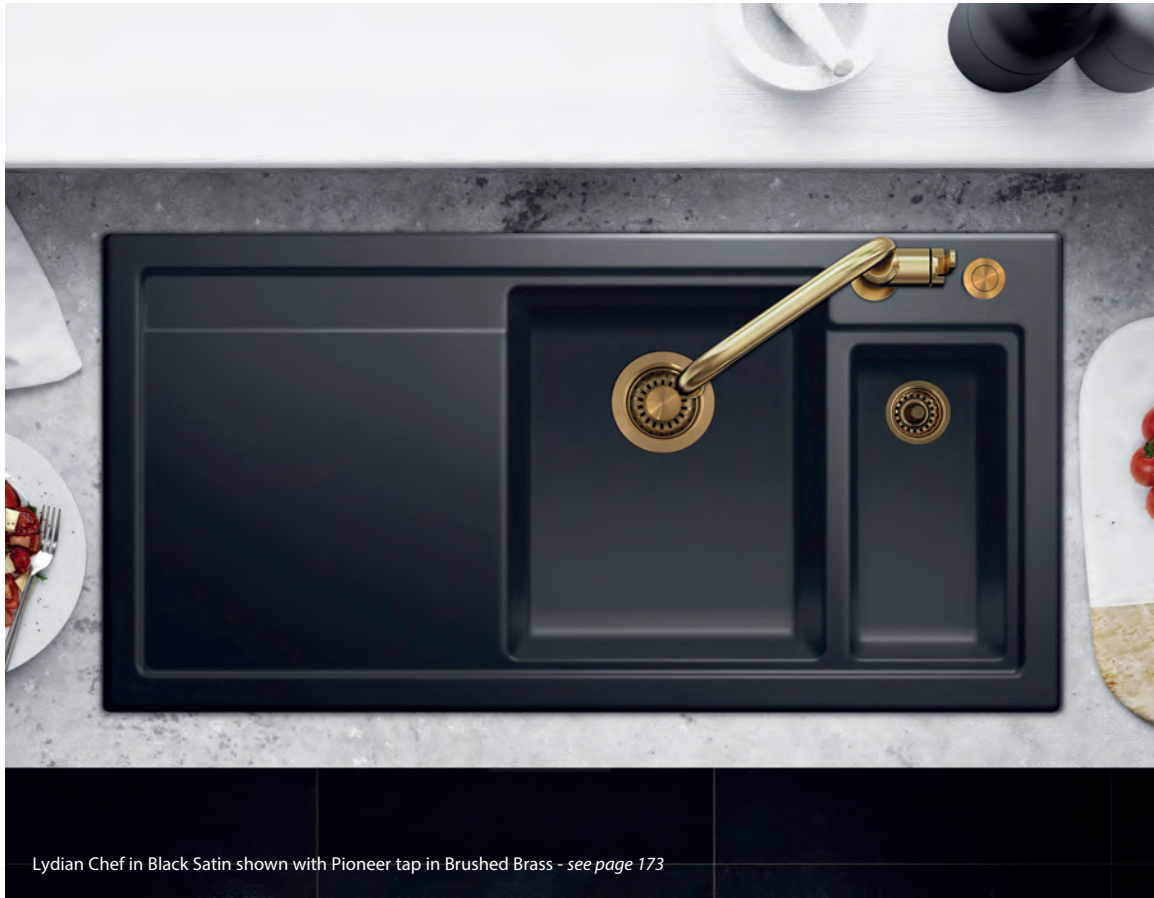

Lydian Chef in Black Satin shown with Pioneer tap in Brushed Brass - see page 173



Lydian Chef in White Gloss shown with Topaz Twist & Spray tap in Brushed Brass - see page 166-167



Topaz tap in Needle Jet mode - see page 166-167

Presto Automatic Waste Kits

For full details about the Presto Automatic Waste see page 127



Chrome
WP15CP £48



Stainless Steel
WP15SS £48



Artisan Brass
WP15AB £116



Regency Copper
WP15RC £114



Matt Black
WP15MB £79



Lydian Chef 1.5 bowl and drainer

Ref. LYD1020L left hand drainer
White **£672** Colours **£698**

Ref. LYD1020R right hand drainer
White **£672** Colours **£698**

Sink prices exclude waste, see choice of finishes

Installation: Inset
Overall size: 1000/510 mm
Bowl size: 332/395/185 mm
Half bowl: 161/332/140 mm
Cutout size: 977/488 mm
Minimum cabinet size: 600 mm
Tap-holes: 1 handed

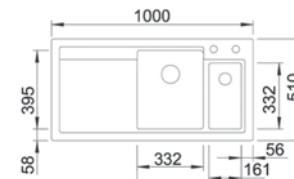

LYDIAN CHEF

The **Lydian Chef** combines smart aesthetics with a carefully considered ergonomic design. The large bowl and outset half-bowl bear the signature of a professional kitchen.

The highest quality finishes have been a priority and special attention is given during the manufacturing process to ensure perfectly smooth surfaces and engineered straight edges. The fired glazed surfaces in white gloss or coloured satin finishes are particularly fine and complete this sink's impressive credentials.

- Slim-edge profile provides a smooth transition to the worktop
- Uniquely practical outset half-bowl for rinsing and draining
- Tap and automatic waste control positioned neatly behind half bowl for clutter-free lines
- Anti-bac, acid and heat resistant surface



Add colour suffix when ordering

Optional Accessories



Ref. WBD426
Wooden Chopping Board **£34**



Ref. COL103
Stainless Steel Colander **£109**
Fits main bowl



Ref. COL106
Colander **£70**
Fits half bowl



Melody Pro in Basalt Satin shown with Toledo pull-out Filter tap in Brushed Nickel - see page 147

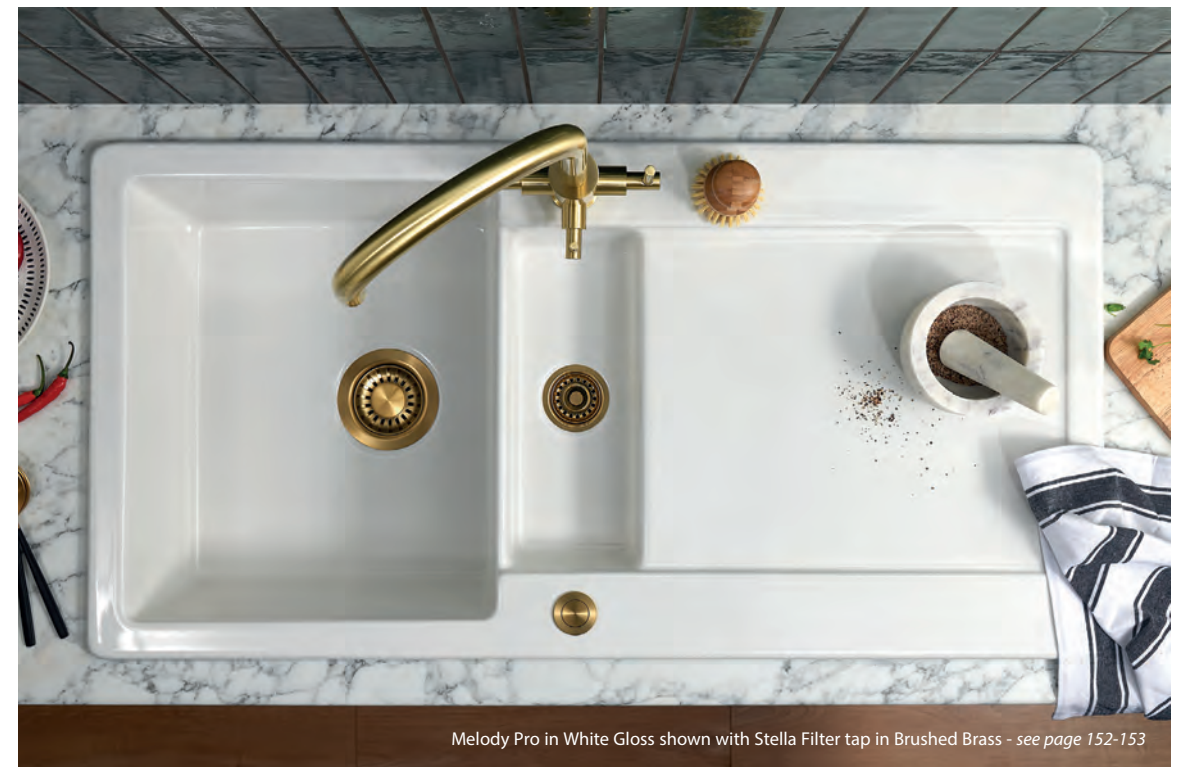

Melody Pro in White Gloss shown with Stella Filter tap in Brushed Brass - see page 152-153

Presto Automatic Waste Kits

For full details about the Presto Automatic Waste see page 127

-  Chrome WP15CP £48
-  Stainless Steel WP15SS £48
-  Artisan Brass WP15AB £116
-  Regency Copper WP15RC £114
-  Matt Black WP15MB £79



Toledo tap extended



Melody Pro 1.5 bowl & drainer

Ref. MEL1020 White £492

Ref. MEL1020 Colours £517

Sink prices exclude waste, see choice of finishes

Installation: Inset
 Overall size: 1000/510 mm
 Bowl size: 360/434/185 mm
 Half bowl: 132/330/85 mm
 Cutout size: 964/474 mm
 Minimum cabinet size: 600 mm
 Tap-holes: 1 reversible

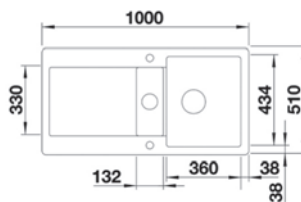

MELODY PRO



The Melody's understated design with its minimalist drainer and the thin profile edges harmonise beautifully, resulting in a highly cool and practical sink. As the Melody is one of our premiere quality ceramics the finish quality sets it apart from its peers.

- Slim-edge profile provides a smooth transition to the worktop
- Understated styling provide an ultra-modern aesthetic
- Slender half bowl allows maximisation of main bowl
- Anti-bac, acid and heat resistant surface

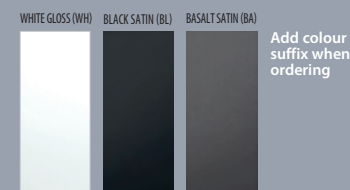

Stella Filter tap in Brushed Brass - see page 152-153



Harmony XL in White Gloss shown with Krypton Filter tap in Brushed Brass - see page 154



Harmony MB in Basalt Satin shown with Topaz Twist & Spray tap in Brushed Nickel - see page 166-167

HARMONY



The **Harmony** is a family of four, all sharing smart twin draining channels and distinctive semi-circular tap platforms. These sinks are part of our premiere range and are set apart from other ceramic sinks with their near flawless finish and elegant lines.

The **Harmony MB** is the flagship model for multi-tasking, with a large main bowl and an invaluable half bowl for rinsing and draining.

The **Harmony XL** is the largest of the single bowl collection with a high-capacity bowl and expansive draining area, an ideal choice to handle range cooker size trays and oversize pots.

The **Harmony XW** is mid-size single bowl sink with a drainer waste positioned in a highly useful draining recess, a perfect solution for the disposal of liquids when the bowl is in use.

The **Harmony Compact's** very compact dimensions offer the opportunity to fit a premiere quality ceramic sink in the smallest of spaces and still provide useful size work zones.

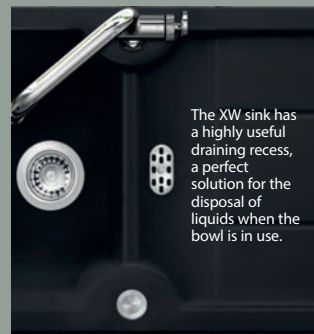

The XW sink has a highly useful draining recess, a perfect solution for the disposal of liquids when the bowl is in use.

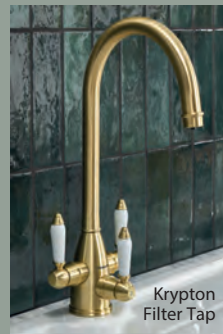

Krypton Filter Tap

WHITE GLOSS (WH) BLACK SATIN (BL) BASALT SATIN (BA)

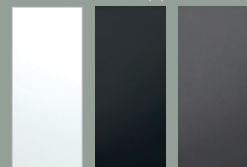

Add colour suffix when ordering

Presto Automatic Waste Kits

For full details about the Presto Automatic Waste see page 127



Chrome
WP10CP £44
WP15CP £48
WP12CP £43



Stainless Steel
WP10SS £44
WP15SS £48
WP12SS £43



Artisan Brass
WP10AB £114
WP15AB £116
WP12AB £94



Regency Copper
WP10RC £114
WP15RC £114
WP12RC £94



Matt Black
WP10MB £75
WP15MB £79
WP12MB £68

Harmony MB WP15**

Harmony XL WP10**

Harmony Compact WP10**

Harmony XW WP12**

Harmony MB 1.5 bowl and drainer

Ref. HAR1020 White £480

Ref. HAR1020 Colours £505

Sink prices exclude waste, see choice of finishes

Installation: Inset

Overall size: 1000/500 mm

Bowl size: 350/420/185 mm

Half bowl: 150/420/100 mm

Cutout size: 977/478 mm

Minimum cabinet size: 600 mm

Tap-holes: 1 reversible

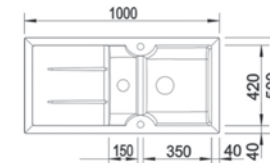

Harmony XL Large bowl and drainer

Ref. HAR1010 White £499

Ref. HAR1010 Colours £524

Sink prices exclude waste, see choice of finishes

Installation: Inset

Overall size: 1000/500 mm

Bowl size: 480/420/175 mm

Cutout size: 977/477 mm

Minimum cabinet size: 600 mm

Tap-holes: 1 reversible

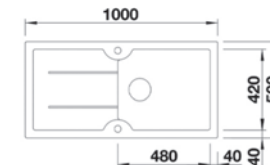

Harmony XW Single Bowl and drainer

Ref. HAR9110 White £440

Ref. HAR9110 Colours £462

Sink prices exclude waste, see choice of finishes

Installation: Inset

Overall size: 915/500 mm

Bowl size: 352/420/187 mm

Cutout size: 892/478 mm

Minimum cabinet size: 500 mm

Tap-holes: 1 reversible

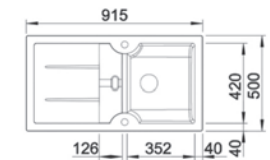

Harmony Compact Small bowl & drainer

Ref. HAR7810 White £405

Ref. HAR7810 Colours £426

Sink prices exclude waste, see choice of finishes

Installation: Inset

Overall size: 780/500 mm

Bowl size: 350/420/175 mm

Cutout size: 758/478 mm

Minimum cabinet size: 450 mm

Tap-holes: 1 reversible

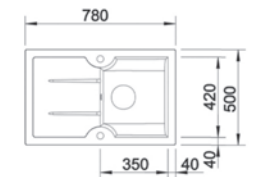



Opus XL in Black Satin shown with Kira Pull-out tap in Chrome - see pages 189



Opus XL in Black Satin shown with Kira Pull-out tap in Chrome - see pages 189

SINKS CERAMIC INSET

Presto Automatic Waste Kits

For full details about the Presto Automatic Waste see page 127



Chrome
WP10CP £48



Stainless Steel
WP10SS 48



Artisan Brass
WP10AB £114



Regency Copper
WP10RC £114



Matt Black
WP10MB £75



Opus XL Large bowl & drainer
Ref. OPU1010L left hand drainer
 White £510 Colours £536
Ref. OPU1010R right hand drainer
 White £510 Colours £536

Sink prices exclude waste, see choice of finishes

Installation: Inset
 Overall size: 1000/510 mm
 Bowl size: 465/348/185 mm
 Cutout size: 977/488 mm
 Minimum cabinet size: 600 mm
 Tap-holes: 1 handed

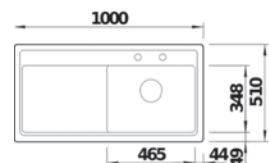

Opus Compact Small bowl & drainer
Ref. OPU861L left hand drainer
 White £440 Colours £463
Ref. OPU861R right hand drainer
 White £440 Colours £463

Sink prices exclude waste, see choice of finishes

Installation: Inset
 Overall size: 860/510 mm
 Bowl size: 378/348/185 mm
 Cutout size: 837/488 mm
 Minimum cabinet size: 450 mm
 Tap-holes: 1 handed

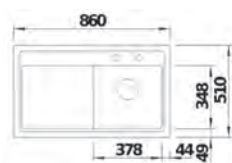

OPUS



The **Opus** is designed with a distinctive linear tap ledge that compliments its minimalist drainer. Both models share a premiere build quality with sublime glazing that define these sinks. The **Opus Compact** is a great choice when space is at a premium whilst offering useful bowl dimensions. The **Opus XL** has particularly high-capacity bowl and large draining platform thus ensuring this model's high workload status.

- Slim-edge profile provides a smooth transition to the worktop
- Defined linear ledge contains spills and provide a 'dry' platform for accessories
- Compact model fits within 45cm cabinet
- Anti-bac, acid and heat resistant surface



Add colour suffix when ordering



Kira tap extended



Sonnet SO15BWT shown with Juno tap in chrome - see pages 172



Standard Waste Kits

		Artisan Brass W90AB £69 W90AB £53	Artisan Brass W60AB £43
Optional Coloured Wastes			
1.0 Bowl = 1 x W900**		Regency Copper W90RC £69 W90RC £53	Regency Copper W60RC £43
1.5 Bowl = 1 x W900** + 1 x W60**		Matt Black W90MB £69 W90MB £53	Matt Black W60MB £37
2.0 Bowl = 2 x W90			

SONNET

WHITE CHAMPAGNE

The **Sonnet** will brighten up any kitchen with its stylish contemporary design and smooth curves.



Sonnet Single bowl and drainer
Ref. SO1BWT White £308
Ref. SO1BCH Champagne £361
Standard Waste WKIT1 S/S £28

Installation: Inset
 Overall size: 855/500 mm
 Bowl size: 340/370/200 mm
 Cutout size: 815/460 mm
 Minimum cabinet size: 500 mm
 Tap-holes: 1 reversible

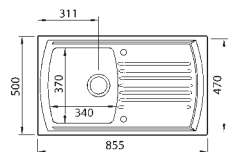

Sonnet 1.5 bowl and drainer
Ref. SO15BWT White £319
Ref. SO15BCH Champagne £368
Standard Waste WKIT2 S/S £52

Installation: Inset
 Overall size: 995/500 mm
 Bowl size: 330/370/210 mm
 Half bowl: 135/253/120 mm
 Cutout size: 950/460 mm
 Minimum cabinet size: 600 mm
 Tap-holes: 1 reversible

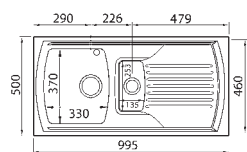

Sonnet Double bowl and drainer
Ref. SO2BDWT White £416
Standard Waste WKIT2 S/S £52

Installation: Inset
 Overall size: 1205/500 mm
 Bowl sizes: 335/373/200 mm
 Cutout size: 1170/465 mm
 Minimum cabinet size: 800 mm
 Tap-holes: 1 reversible

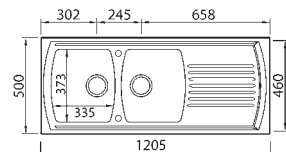

Icons Explained
 see page 29.



Jarla 1010 shown with Pioneer Pull-out tap in Brushed Brass - see page 192



Standard Waste Kit



Artisan Brass
W900AB £69
W90AB £53



Regency Copper
W900RC £69
W90RC £53

Optional Coloured Wastes

1.0 Bowl = 1 x W900**

1.5 Bowl = 2 x W90**



Matt Black
W900MB £69
W90MB £53



Jarla 1020 shown with Mariner Filter tap in Matt Black - see pages 144-145

JARLA



The **Jarla** are Denby's latest addition of contemporary sinks. The design brief was to offer a slim-edge profile together with 20mm radius bowls resulting in a very smart design which combined with the highest quality finish makes this a superb choice for your home.



Jarla Mini Single bowl and drainer
Ref. **JAR1030** White **£316**
Standard Waste **WKIT1** S/S **£28**

Installation: Inset
Overall size: 857/500/215 mm
Bowl size: 417/412/190 mm
Cutout size: 840/480 mm
Minimum cabinet size: 600 mm
Tap-Holes: 1 reversible

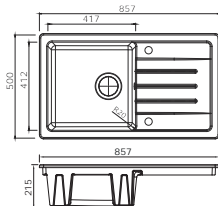

Jarla Single bowl and drainer
Ref. **JAR1010** White **£361**
Ref. **JAR1010B** Black **£390**
Standard Waste **WKIT1** S/S **£28**

Installation: Inset
Overall size: 1000/500/210 mm
Bowl size: 447/412/195 mm
Cutout size: 980/480 mm
Minimum cabinet size: 600 mm
Tap-Holes: 1 reversible

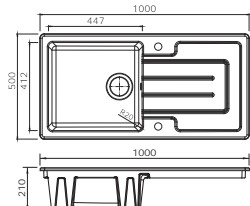

Jarla 1.5 bowl and drainer
Ref. **JAR1020** White **£386**
Ref. **JAR1020B** Black **£425**
Standard Waste **WKIT2** S/S **£52**

Installation: Inset
Overall size: 1000/500/210 mm
Bowl size: 340/415/190 mm
Half bowl: 170/299/142 mm
Cutout size: 980/480 mm
Minimum cabinet size: 600 mm
Tap-Holes: 1 reversible

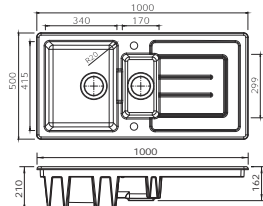

Jarla Mini shown with Magus 3 Kettle tap in Chrome - see page 134-135



Icons Explained see page 29.

Metro 1.5 bowl
Ref. MET1020 White £381
Ref. MET1020G Sea Mist £482
Standard Waste WKIT2 S/S £52
 Installation: Inset or Undermount
 Overall size: 595/460 mm
 Bowl size: 326/390/194 mm
 Half size: 172/390/194 mm
 Cutout size: Template available
 Minimum cabinet size:
 600 mm (Inset) 700 mm (Undermount)
 Tap-holes: No

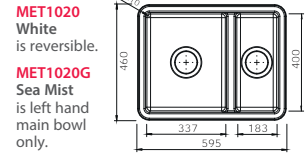

MET1020G Sea Mist Wastes
 1 x W900** + 1 x W90**
 (Has overflow)

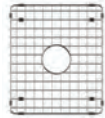

Metro 1020 Grid
Ref. Grid20 £50



Metro 1020 pictured with grid



Metro 1020 pictured in Sea Mist



Metro 1070 shown with Karuma Pull-out tap in Chrome - see page 190

Metro 1.5 bowl (Reversible)
Ref. MET1070 White £348
Standard Waste WKIT2 S/S £52
 Installation: Inset or Undermount
 Overall size: 555/430 mm
 Bowl size: 330/370/195 mm
 Half bowl: 150/370/195 mm
 Cutout size: Template available
 Minimum cabinet size: 600 mm
 Tap-holes: No

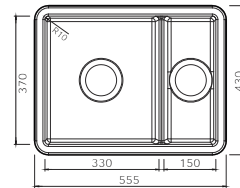

METRO UNDERMOUNT/INSET



The **Metro** collection are a versatile range of bowls that can be installed as either undermount or inset installations. There are three single bowl options to select, choose a stand alone or even a combination of two together. The multi-combined bowl option is particularly smart with extra-slim partition walls providing a more sophisticated look than other ceramic options.

Metro sinks are available in gloss White and matt Sea Mist.

Standard Waste Kit

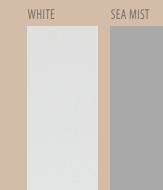

Optional Coloured Wastes

1.0 Bowl = 1 x W900**
 1.3 Bowl = 1 x W900** + 1 x W90**
 1.5 Bowl = 2 x W90** (No overflow)



Metro 1.3 bowl (left hand main bowl only)

Ref. MET1010 White £381
Standard Waste WKIT2 S/S £52

Installation: Inset or Undermount
 Overall size: 595/520 mm
 Bowl size: 350/450/194 mm
 Third bowl: 162/290/194 mm
 Cutout size: Template available
 Minimum cabinet size:
 600 mm (Inset) 700 mm (Undermount)
 Tap-holes: No

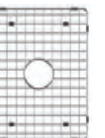

Metro 1010 Grid
Ref. Grid10 £63

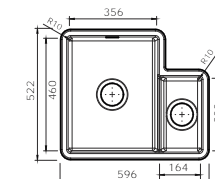

Icons Explained see page 29.



Metro 1070 shown with Karuma Pull-out tap in Chrome - see page 190



Metro Half bowl

Ref. MET1030 White £230
Standard Waste WKIT1 S/S £28

Installation: Inset or Undermount
 Overall size: 234/460 mm
 Bowl size: 174/400/194 mm
 Cutout size: Template available
 Minimum cabinet size: 300 mm
 Tap-Holes: No

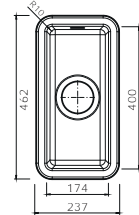

Metro Large bowl

Ref. MET1050 White £381
Ref. MET1050G Sea Mist £482
Standard Waste WKIT1 S/S £28

Installation: Inset or Undermount
 Overall size: 595/460 mm
 Bowl size: 535/400/194 mm
 Cutout size: Template available
 Minimum cabinet size:
 600 mm (Inset) 700 mm (Undermount)
 Tap-Holes: No

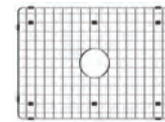
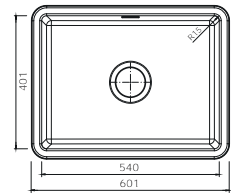

Metro 1050 Grid
Ref. Grid50 £75



Metro 1050 pictured with grid

WHITE	SEA MIST		Standard Waste Kit		Optional Coloured Wastes		
			1.0 Bowl = 1 x W900**	Artisan Brass	1.3 Bowl = 1 x W900**	Regency Copper	Matt Black
			+ 1 x W90**	W900AB £69	+ 1 x W90**	W900RC £69	W900MB £69
			1.5 Bowl = 2 x W90**	W90AB £53	(No overflow)	W90RC £53	W90MB £53

Metro Medium bowl
Ref. MET1040 White £278
Ref. MET1040G Sea Mist £361
Standard Waste WKIT1 S/S £28

Installation: Inset or Undermount
 Overall size: 460/460 mm
 Bowl size: 400/400/194 mm
 Cutout size: Template available
 Minimum cabinet size: 500 mm
 Tap-Holes: No

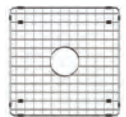
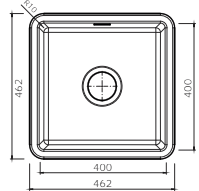

Metro 1040 Grid
Ref. Grid40 £63



Metro Round bowl

Ref. MET1060 White £257
Ref. MET1060G Sea Mist £349
Standard Waste WKIT1 S/S £28

Installation: Inset or Undermount
 Overall size: 445/445 mm
 Bowl size: 384/384/172 mm
 Cutout size: Template available
 Minimum cabinet size: 450 mm
 Tap-Holes: No

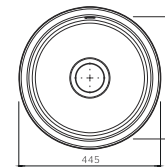



Avola 150 in White Gloss shown with Alasia Pro tap in Chrome - see page 196-197



Avola 500 in Black Satin shown with Santor Pull-out tap in Brushed Brass - see page 191

AVOLA UNDERMOUNT

Chrome W900C £30
 Chrome W60C £27
 Artisan Brass W900AB £69
 Artisan Brass W60AB £43
 Regency Copper W900RC £69
 Regency Copper W60RC £43
 Matt Black W900MB £69
 Matt Black W60MB £37

R15
 HYGIENIC SURFACE

The **Avola** is our premiere ceramic range of undermounts, manufactured to the highest of tolerances ensuring faultlessly smooth surfaces and beautiful glazed finishes. There are three single bowls ranging in size from compact to catering size. There is a smart 1.5 bowl model which is extremely versatile and very usefully fits within a 60cm cabinet - perfect when space is at a premium. Available in a sparkling white gloss and two dark matt colours that will add drama to the kitchen.

1.0 Bowl = 1 x W900** 1.5 Bowl = 1 x W900** + 1 x W60**



Add colour suffix when ordering

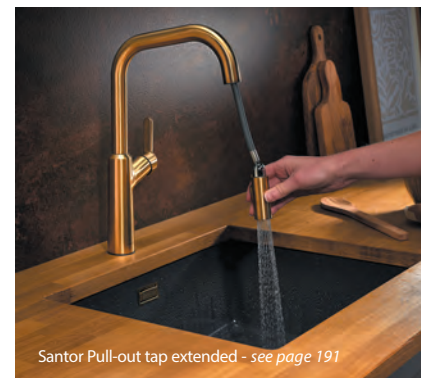

Santor Pull-out tap extended - see page 191

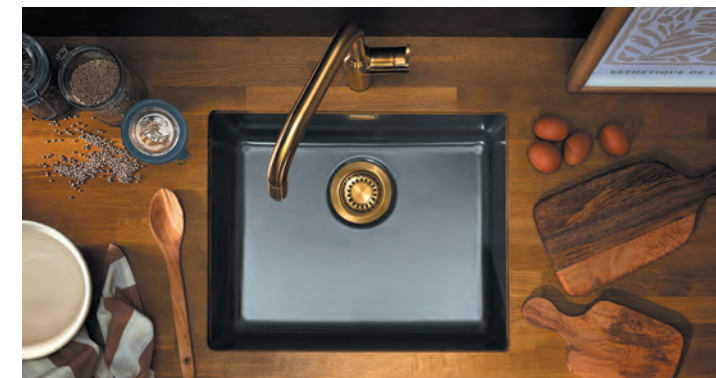

Alasia Pro tap in Needle Jet mode



Avola 1.5 bowl
Ref. AVO U150 White £489
Ref. AVO U150 Colours £519

Overall size: 567/456 mm
 Bowl size: 350/396/185 mm
 Half bowl: 150/396/130 mm
 Cutout size: Template Available
 Minimum cabinet size: 600 mm

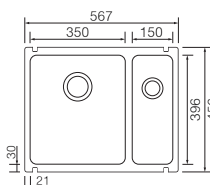

Avola Single bowl
Ref. AVO U375 White £419
Ref. AVO U375 Colours £449

Overall size: 414/456 mm
 Bowl size: 374/396/185 mm
 Cutout size: Template Available
 Minimum cabinet size: 450 mm

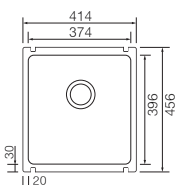

Avola Single bowl
Ref. AVO U500 White £479
Ref. AVO U500 Colours £509

Overall size: 543/456 mm
 Bowl size: 500/396/185 mm
 Cutout size: Template Available
 Minimum cabinet size: 600 mm

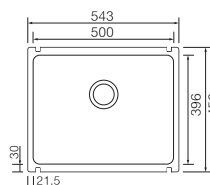

Avola Single bowl
Ref. AVO U700 White £529
Ref. AVO U700 Colours £559

Overall size: 751/456 mm
 Bowl size: 700/396/203 mm
 Cutout size: Template Available
 Minimum cabinet size: 800 mm

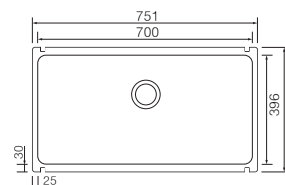

Icons Explained see page 29.

APRON FRONTED

The following pages contain a comprehensive collection of Butler sinks. We offer two main ranges; our 'British Classics' are quintessential vintage designs which are handmade by skilled artisans, while our 'Contemporary Collection' gives a modern tilt to the traditional Butler sink. We also include some practical utilitarian sinks that are ideal for the utility or boot room.



In this installation the sink is fitted directly onto a cabinet with its front fascia exposed. This type of installation is only suitable for solid surface worktops such as Granite, Marble or Wood.



BRITISH CLASSICS

Pages 49 - 61

Our British Classics are a collection of handmade sinks using traditional methods by skilled artisans who pride themselves in reproducing heritage icons.



- Timeless appeal
- Soft sculpture profiles
- Traditional thick walls
- Solid wall construction
- Glazed twice for a beautiful surface finish
- Hand-made by skilled Artisans
- Made in Britain

CONTEMPORARY COLLECTION

Pages 62 - 66

Our Contemporary Collection is a modern interpretation of the classic Butler sink. The use of modern manufacturing techniques has resulted in a slimmer profiled design bringing a layer of modernity to these traditional classics.



- Slim-profile walls
- Light weight construction
- Suitable for modern and traditional styles

UTILITY & LAUNDRY

Pages 66 - 67

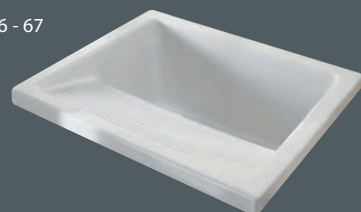

Belfast TBE600 shown with Davina Twist & Spray tap in Chrome - see page 170

BELFAST BRITISH CLASSICS

This British Classics **Belfast** faithfully follows the original architectural lines of its forebears, boasting thick softly profiled walls with a classic weir overflow.

KEY FEATURES

- 60mm waste outlet
- Lifetime warranty
- Luxurious, durable, anti-bacterial glaze finish
- Handmade by Master Craftsmen

Belfast Waste Options (85mm Flange)



Belfast Single bowl
Ref. **TBE600** White £483

Installation: Apron Front
Overall size: 595/460/255 mm
Bowl size: 525/390/217 mm
Overflow: Yes
Tap-holes: No

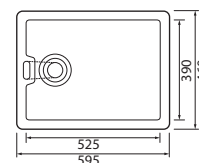

Belfast Mini Single bowl
Ref. **TBE460** White £458

Installation: Apron Front
Overall size: 460/380/205 mm
Bowl size: 390/310/180 mm
Overflow: Yes
Tap-holes: No

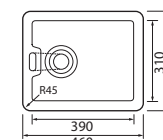

Belfast Mini



Oxford shown with Thomas Denby waste in Brushed Steel



Oxford shown with Elegance tap in Brushed Nickel - see page 209



Oxford Single bowl
Ref. TOX600 White £465
 Installation: Apron Front
 Overall size: 595/465/230 mm
 Bowl size: 535/405/199 mm
 Overflow: Yes
 Tap-holes: No

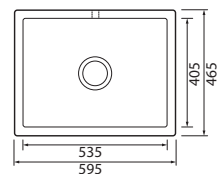

OXFORD BRITISH CLASSICS

The **Oxford** has a more modern design with its rectilinear lines. It has a strong presence in the kitchen with its deep apron front and capacious dimensions.

- 90mm waste outlet
- Lifetime warranty
- Luxurious, durable, anti-bacterial glaze finish
- Handmade by Master Craftsmen

Thomas Denby Wastes



Norfolk shown with Elegance Bridge Twist & Spray tap in Brushed Bronze - see page 209

NORFOLK BRITISH CLASSICS

The **Norfolk** has all the DNA of the traditional Belfast but with the quintessential weir overflow positioned at the rear instead of the side wall. This symmetrical arrangement adds a more contemporary look to this classic sink.

- 60mm waste outlet
- Lifetime warranty
- Luxurious, durable, anti-bacterial glaze finish
- Handmade by Master Craftsmen

Norfolk Waste Options (85mm Flange)



Norfolk shown with Traditional Pull-Out Spray in Brushed Bronze - see page 207



Norfolk Single bowl
Ref. TNO600 White £559
 Installation: Apron Front
 Overall size: 595/460/229 mm
 Bowl size: 525/390/199 mm
 Overflow: Yes
 Tap-holes: No

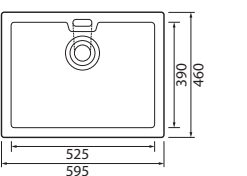



ESSEX BRITISH CLASSICS

The **Essex** is our biggest single bowl sink in the British Classics collection and offers a spacious bowl for serious scullery drudgery! This centre piece sink will bring splendour to your kitchen with its beautifully handcrafted lines and lustrous finish.

- 90mm waste outlet
- Lifetime warranty
- Luxurious, durable, anti-bacterial glaze finish
- Handmade by Master Craftsmen

Thomas Denby Wastes



Essex shown with Elegance Twist & Spray tap in Chrome - see page 209



Essex Single bowl
Ref. **TES800** White £918
Installation: Apron Front
Overall size: 795/460/254 mm
Bowl size: 735/400/224 mm
Overflow: Yes
Tap-holes: No

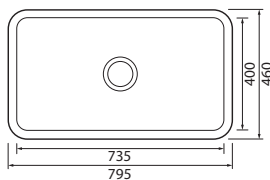

TUDOR BRITISH CLASSICS

The **Tudor** is our most compact twin bowl Farmhouse and an ideal choice for less than huge kitchens whilst retaining generous bowl sizes for heavy duties. The traditional solid wall construction is hand crafted with brilliant bright glaze giving the Tudor its air of authority.

- 90mm waste outlet
- Lifetime warranty
- Luxurious, durable, anti-bacterial glaze finish
- Handmade by Master Craftsmen

Thomas Denby Wastes



Tudor Double bowl
Ref. **TTU800** White £918
Installation: Apron Front
Overall size: 800/500/220 mm
Bowl sizes: 365/440/195 mm
Overflow: Yes
Tap-holes: No

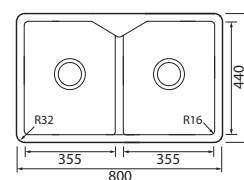

Tudor shown with Thomas Denby wastes in Brushed Brass





Windsor shown with Thomas Denby waste in Brushed Brass

WINDSOR BRITISH CLASSICS

The **Windsor's** soft contours and chunky walls exude an individual charm. The bowl is broad but the depth is shallower than its peers in the British Classic collection.

- 90mm waste outlet
- Lifetime warranty
- Luxurious, durable, anti-bacterial glaze finish
- Handmade by Master Craftsmen

Thomas Denby Wastes



Windsor Single bowl
Ref. **TW1600** White £465
Installation: Apron Front
Overall size: 595/460/200 mm
Bowl size: 535/400/170 mm
Overflow: Yes
Tap-holes: No

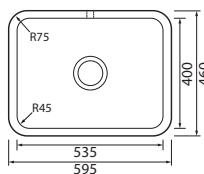

Windsor shown with Elegance tap in Brushed Brass - see page 209



Chiltern shown with Magus 4 Kettle tap in Matt Black - see page 136-137

CHILTERN BRITISH CLASSICS

The **Chiltern** is the sister sink to the Windsor, but with a cravat! This flamboyant Belfast will add a characterful presence to your kitchen and is sure to attract many compliments at your next kitchen soirée.

- 90mm waste outlet
- Lifetime warranty
- Luxurious, durable, anti-bacterial glaze finish
- Handmade by Master Craftsmen

Thomas Denby Wastes



Chiltern Single bowl
Ref. **TCH600** White £665
Installation: Apron Front
Overall size: 595/460/200 mm
Bowl size: 535/400/170 mm
Overflow: Yes
Tap-holes: No

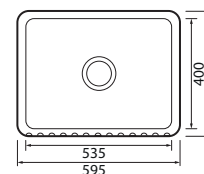

Chiltern shown with Modern Pull-Out Spray in Matt Black - see page 206



Suffolk shown with Elegance Twist & Spray tap in Chrome - see page 209

SUFFOLK BRITISH CLASSICS

The **Suffolk** has a useful double bowl with an offset dividing wall. The generously sized main bowl is perfect to take on oversized items for washing while the half bowl is left free for smaller tasks.

- 90mm waste outlet
- Lifetime warranty
- Luxurious, durable, anti-bacterial glaze finish
- Handmade by Master Craftsmen
- Overflow into adjacent bowl facilitated by lower bowl divide
- Reversible LH/RH Main bowl



Suffolk 1.5 bowl (Reversible)
Ref. TSU800 White £1056
 Installation: Apron Front
 Overall size: 795/465/220 mm
 Bowl size: 500/405/195 mm
 Half bowl: 205/405/195 mm
 Overflow: No
 Tap-holes: No

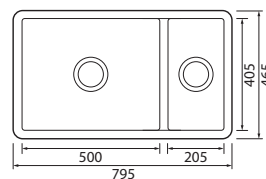

Thomas Denby Wastes



Bredon shown with Longdon Kettle tap in Chrome - see page 140-141

BREDON BRITISH CLASSICS

The **Bredon** is the sister to the Suffolk Farmhouse and amongst its many attributes is a beautifully fluted facade adding a glamorous style to your home. There are two bowls with dramatically different capacities – a 50cm option to take on big scale items and a compact 20cm providing a desirable water-saving option.

- 90mm waste outlet
- Lifetime warranty
- Luxurious, durable, anti-bacterial glaze finish
- Handmade by Master Craftsmen
- Overflow into adjacent bowl facilitated by lower bowl divide
- Reversible LH/RH Main bowl



Bredon 1.5 bowl (Reversible)
Ref. TBR800 White £1056
 Installation: Apron Front Fluted
 Overall size: 795/465/220 mm
 Bowl size: 500/405/195 mm
 Half bowl: 205/405/195 mm
 Overflow: No
 Tap-holes: No

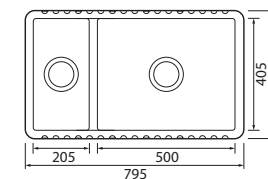

Thomas Denby Wastes



Suffolk shown with Traditional Pull-Out Spray in Chrome - see page 207



Bredon shown with Traditional Pull-Out Spray in Chrome - see page 207



CUMBRIA BRITISH CLASSICS

The **Cumbria** is our biggest Farmhouse sink with two generous equal sized bowls. The soft contours and large scale of the Cumbria create an extravagant opulence that will be the focal point in the grandest of kitchens. If a high workload and twin tasking is required, there is no better choice.

- 90mm waste outlet
- Lifetime warranty
- Luxurious, durable, anti-bacterial glaze finish
- Handmade by Master Craftsmen

Thomas Denby Wastes



Chrome
TD2WC £113

Bronze PVD
TD2WBR £190

Brushed Steel
TD2WBS £129

Regency Copper PVD
TD2WRC £190

Polished Nickel PVD
TD2WNI £190

Brushed Brass PVD
TD2WBB £190

Cumbria shown with Thomas Denby wastes in Brushed Brass



Cumbria Double bowl
Ref. **TCU1000** White £1374

Installation: Apron Front
Overall size: 1000/535/220 mm
Bowl sizes: 455/455/190 mm
Overflow: Yes
Tap-holes: No

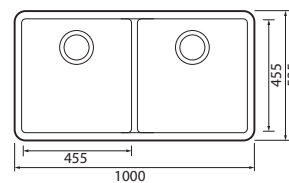

COTSWOLD BRITISH CLASSICS

The **Cotswold** is the sister sink to the Cumbria, our biggest 100cm Farmhouse and is the flagship of our sink fleet with capacious dimensions and certainly makes a statement with its distinctive fluted façade.

- 90mm waste outlet
- Lifetime warranty
- Luxurious, durable, anti-bacterial glaze finish
- Handmade by Master Craftsmen

Thomas Denby Wastes



Chrome
TD2WC £113

Bronze PVD
TD2WBR £190

Brushed Steel
TD2WBS £129

Regency Copper PVD
TD2WRC £190

Polished Nickel PVD
TD2WNI £190

Brushed Brass PVD
TD2WBB £190

Cotswold shown with Stella Filter Tap - see page 152-153 & Pull-Out Spray in Chrome - see page 206



Cotswold Double bowl
Ref. **TCT1000** White £1374

Installation: Apron Front
Overall size: 1000/535/220 mm
Bowl sizes: 455/455/190 mm
Overflow: Yes
Tap-holes: No

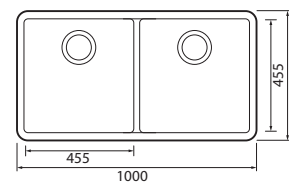

Elegance Bridge Twist & Spray tap in Brushed Bronze - see page 209



Longdon Kettle tap - see page 140 & Pull-Out Spray in Chrome - see page 207



Wessex shown with Elegance Twist & Spray tap in Brushed Brass - see page 209



Wessex Double bowl
Ref. TWE900 White £918
 Installation: Apron Front
 Overall size: 895/465/229 mm
 Bowl sizes: 403/405/199 mm
 Overflow: Yes
 Tap-holes: No

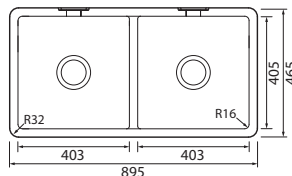

WESSEX BRITISH CLASSICS

The **Wessex** 'Goldilocks' dimension of 90cm is a great scale for most kitchens providing a strong visual impact and a brilliant workhorse with its capacious twin bowls. This centre piece sink will bring splendour to your kitchen with its beautifully handcrafted lines and lustrous finish.

- 90mm waste outlet
- Lifetime warranty
- Luxurious, durable, anti-bacterial glaze finish
- Handmade by Master Craftsmen

Thomas Denby Wastes



Buxton shown with Traditional Pull-Out Spray in Brushed Brass - see page 207



Buxton Double bowl
Ref. TBU900 White £918
 Installation: Apron Front
 Overall size: 895/465/229 mm
 Bowl sizes: 403/405/199 mm
 Overflow: Yes
 Tap-holes: No

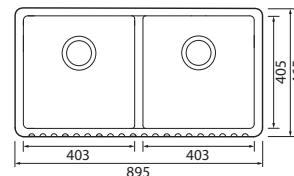

Longdon Kettle tap in Brushed Brass - see page 140-141

BUXTON BRITISH CLASSICS

The **Buxton** is the sister sink to the Wessex. This classic Farmhouse offers twin bowls of chore-swallowing dimensions, and at 90cm is a great fit for most kitchens whilst creating a strong focal point with its exquisite, fluted detailing.

- 90mm waste outlet
- Lifetime warranty
- Luxurious, durable, anti-bacterial glaze finish
- Handmade by Master Craftsmen

Thomas Denby Wastes



LEGACY

The **Legacy** Butler sinks combine tradition with modernity, the slimmer wall construction gives this classic design a subtle elegance that contrasts with the more robust architecture of the British Classics shown on the preceding pages. We offer two installation options; without a tap ledge, or with a tap platform suitable for a Monobloc mixer tap.

This option negates the bother of drilling a hole in the work surface.

Thomas Denby Wastes Alternative PVD wastes also available see page 126



LEGACY 600



Legacy 600 Single bowl
Ref. LEG600 White **£393**
Standard Waste
WKIT1 S/S £28

Installation: Apron Front
Overall: 595/450/220 mm
Bowl size: 551/406/198 mm
Overflow: No
Tap-Holes: No
Weight: 31kg

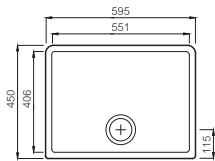

Legacy 600 shown with Alrish tap in Chrome - see page 213



Legacy 800T shown with Alrish tap in Chrome - see page 213

LEGACY 600T & 800T



Legacy 600T Single bowl with Tap Ledge
Ref. LEG600T White **£393**
Standard Waste
WKIT1 S/S £28

Installation: Apron Front
Overall: 595/450/220 mm
Bowl size: 551/406/198 mm
Overflow: No Weight: 31kg
Tap-Holes: 1
(available without tap hole by Special Order)

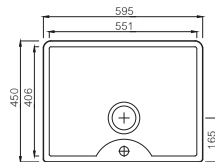

Legacy 800T Single bowl with Tap Ledge
Ref. LEG800T White **£492**
Standard Waste
WKIT1 S/S £28

Installation: Apron Front
Overall: 795/500/220 mm
Bowl size: 751/456/198 mm
Overflow: No Weight: 41kg
Tap-Holes: 1
(available without tap hole by Special Order)

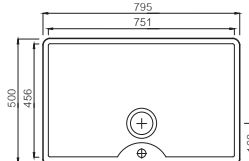

VINTAGE 600

The original weir overflow Belfast much loved by Traditionalists. This one uses the latest technology and is of hollow construction lessening weight and featuring sharper lines.

Available in the traditional White and also in Anthracite for the kitchen that is slightly ahead of the rest.

Vintage 600 Single bowl
Ref. VIN600 White **£362**
Ref. VIN600AN Anthracite **£450**

Installation: Apron Front
Overall size: 595/455/250 mm
Bowl size: 534/393/214 mm
Overflow: Yes
Tap-holes: No

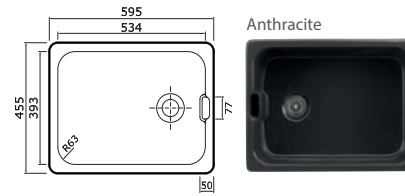

Vintage 600 Waste Options (85mm Flange)



Vintage 600 shown with Juno tap in Chrome - see page 172

VINTAGE 900

The **Vintage 900** has a classical origin but with elements of modernity expressed by the slender wall construction, this cleaner line look sets Vintage in both contemporary and traditional camps.

Vintage 900 Double bowl
Ref. VIN900 White **£544**
Standard Waste **WKIT2 S/S £52**

Installation: Apron Front
Overall size: 895/460/220 mm
Bowl size: 416/419/195 mm
Overflow: Yes
Tap-holes: No

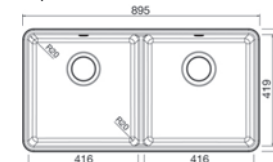

Vintage 900 **Thomas Denby Wastes** Alternative PVD wastes also available see page 126



Vintage 900 shown with Siren Twist & Spray tap in Chrome - see page 164



Vintage 800 pictured with grids

VINTAGE 800

The **Vintage 800** has all the traditional benefits of the classic Farmhouse but with contemporary styling which include a distinctive triangular tap platform and crisp slim walling. Bottom basin grids available.

Vintage 800 Double bowl
Ref. **VIN800** White £487
Standard Waste **WKIT2** S/S £52

Installation: Apron Front
Overall size: 794/490/220 mm
Bowl size: 366/449/195 mm
Overflow: Yes
Tap-Holes: 1

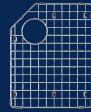

Vintage 800 Grids
Ref. **Grid80R** £56
Ref. **Grid80L** £56

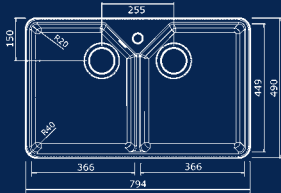

Thomas Denby Wastes

TD1W** = Single Bowl TD2W** = Double Bowl



Chrome
TD1WC £61
TD2WC £113

Bronze PVD
TD1WBR £106
TD2WBR £190

Brushed Steel
TD1WBS £68
TD2WBS £129



Regency Copper PVD
TD1WRC £106
TD2WRC £190

Polished Nickel PVD
TD1WNI £106
TD2WNI £190

Brushed Brass PVD
TD1WBB £106
TD2WBB £190

Alternative PVD wastes also available see page 126

VINTAGE 800S

The **Vintage 800S** is the single bowl version of the 800 useful when more space is required for cleaning those large pans, the finish has the same crisp slim walling.

Vintage 800S Single bowl
Ref. **VIN800S** White £487
Standard Waste **WKIT1** S/S £28

Installation: Apron Front
Overall size: 795/460 mm
Bowl size: 735/400/195 mm
Overflow: Yes Tap-Holes: No

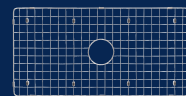
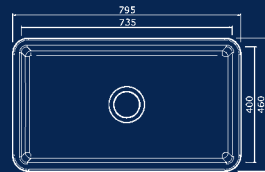

Vintage 800S Grid
Ref. **GRID80S** £88



HERITAGE

The **Heritage** Farmhouse sinks offer true centrepiece qualities with twin full size bowls which are ideal for performing different tasks simultaneously, such as washing up and food prep. These traditional designs have used a slimmer wall construction which has created a more contemporary aesthetic. Both models are supplied with a tap platform suitable for a Monobloc mixer tap, thus avoiding the need to drill out the work surface.

Thomas Denby Wastes 2 Alternative PVD wastes also available see page 126



HERITAGE 800



Heritage 800
Double bowl with Tap Ledge
Ref. **HER800** White £530
Standard Waste **WKIT2** S/S £52

Installation: Apron Front
Overall: 795/500/220 mm
Bowl sizes: 364/456/198 mm
Overflow: No
Tap-Holes: 1 (available without tap hole by Special Order)
Weight: 45kg

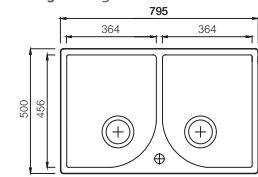

Heritage 800 shown with Alrisha tap in Chrome - see page 213

HERITAGE 900



Heritage 900
Double bowl with Tap Ledge
Ref. **HER900** White £630
Standard Waste **WKIT2** S/S £52

Installation: Apron Front
Overall: 895/550/220 mm
Bowl sizes: 414/505/198 mm
Overflow: No
Tap-Holes: 1 (available without tap hole by Special Order)
Weight: 53kg

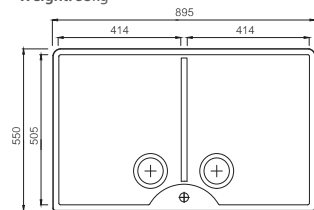



ASHTON 60

The **Ashton** is a classical Butler sink incorporating a tap ledge with three semi-prepared tap-hole positions, making it suitable for a variety of tap styles. A useful accessory ledge has been added to the bowl profile to support a range of accessories - we will be pleased to announce the launch of these very soon. This traditional fireclay sink has a usefully capacious bowl making it a great choice for a family kitchen and an ideal choice for the utility room.



Ashton 60
Single bowl with Tap Ledge
Ref. ASH60 White £390
Standard Waste WKIT1 S/S £28

Installation: Apron Front
Overall: 599/632/220 mm
Bowl sizes: 531/442 mm
Overflow: Yes
Tap-Holes: 1
Weight: 32.5kg

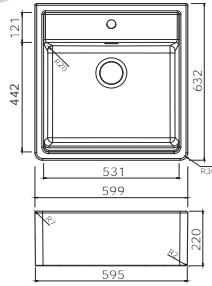

Ashton 60 shown with Titania T12SS Stainless Steel tap - see page 202

LAUNDRY SINKS

A pair of laundry sinks - perfect for when the duvet is just too big for the washing machine.

Laundry Small
Ref. CLS White £295
Installation: Inset
Overall size: 390/605/375 mm
Bowl size: 300/270/340 mm
Minimum cabinet size: Bespoke
Overflow: No

Waste: Clicker sprung plug
Ref. CW2010 Chrome £31

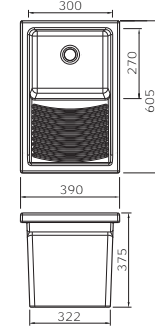

UTILITY SINKS

The **Utility** sinks are available in two sizes, big and very big! These versatile sinks are the ideal solution for the utility room with multi-function abilities from dyeing the curtains to washing the dog!

As Inset



Utility Large



As Lay-On

Utility Medium

Utility Medium
Ref. UT510 White £322
Standard Waste WKIT1 S/S £28

Installation: Lay-On
Overall size: 510/506/235 mm
Bowl size: 449/357/210 mm
Tap-Holes: 1

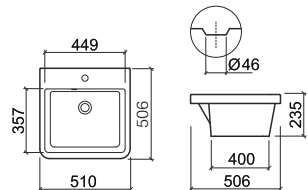

Utility Large
Ref. UT660 White £381
Standard Waste WKIT1 S/S £28

Installation: Lay-On
Overall size: 660/506/236 mm
Bowl size: 599/357/210 mm
Tap-Holes: 1

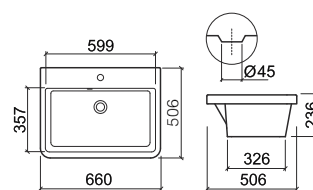

Laundry Large
Ref. CLL White £377
Installation: Inset
Overall size: 745/640/365 mm
Bowl size: 645/325/330 mm
Minimum cabinet size: Bespoke
Overflow: No

Waste: Clicker sprung plug
Ref. CW2010 Chrome £31

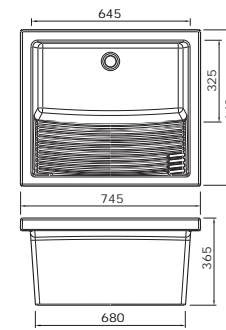

CAST IRON SINKS

The gorgeous hues of enamelled Cast Iron let you bring your personality into your kitchen decor. Its rich finish and long-lasting presence make a bold statement in your kitchen.

Enamelled Cast Iron sinks are built with lasting beauty and the strength to withstand the test of time. The **Saxon** collection are crafted from at least 80% recycled material, and they come with a lifetime warranty. The manufacturing process ensures that each piece is a genuine, handcrafted original.

Cast Iron is simply the best medium for sinks because of its extreme durability, its high gloss surface maintains a rich finish that resists chipping, staining and denting and its sheer strength enables the creation of beautiful shapes and graceful lines. The authenticity of Cast Iron will complement other traditional kitchen features such as your range cooker.

PRODUCT BENEFITS



Dirt-repellent effect
The dirt simply runs off.



Odour-free
Leaves the surface free of smells.



Heat-proof
Not temperature sensitive.



Food-safe
Absolutely safe material.



Hygienic Surface



Made to last
Extremely durable.



Stain-resistant
Food stains cannot stick.



Impact-resistant
Tough and resistant material.



Clearwater Cast Iron and Ceramic Cleaner
Ref. CLEC200 £14
Removes stubborn metal marks and stains with little effort



SAXON COLLECTION

The **Saxon** collection are a family of three sinks with different bowl configurations that will meet the demands of most households. All share the ability to be installed as insets or undermounts. The high gloss lustre of the sinks set them apart from other sinks and their enduring properties that will ensure long lasting fabulous looks.

KEY FEATURES

- Lifetime warranty
- Luxurious high gloss surface
- Anti-bacterial highly durable surface
- Resistant to chipping, staining and denting
- Hand crafted original pieces

clearwater



CLEARWATER CAST IRON SINKS HAVE A LIFETIME WARRANTY



SINKS CAST IRON



Saxon Single bowl
Ref. **SAX C560** White £679
Installation: Inset/Undermount
Overall size: 560/460/240 mm
Bowl size: 490/390/210 mm
Minimum cabinet size: 600 mm
Overflow: No
Tap-holes: No

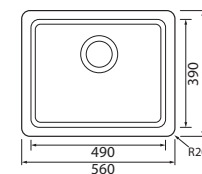

SAXON 560



The **Saxon 560** is a generous size single bowl that will tackle the big and smaller tasks with style. This classy sink exudes quality with its incredibly hardwearing lustrous surface that will set it apart from lesser material sinks. This can be fitted as an inset or an undermount, so there are no excuses not to have one.

Chrome & Coloured Wastes available
see page 71 overleaf for details



Davina Twist & Spray tap in Chrome - see page 170



Saxon 200 shown with Elegance Bridge Twist & Spray tap in Brushed Bronze - see page 209



SAXON 200



The **Saxon 200** makes a wonderful centre piece in the kitchen with its magisterial good looks. This versatile sink boasts two equal bowls of a good size and are an ideal choice for the serious cook allowing space for food prep and clearing up simultaneously.

Chrome & Coloured Wastes available
see page 71 opposite for details



Saxon Double bowl
Ref. SAX C200 White **£849**
Installation: Inset/Undermount
Overall size: 840/460/240 mm
Bowl sizes: 367.5/390/210 mm
Minimum cabinet size: 900 mm
Overflow: No
Tap-holes: No

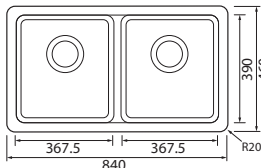

Saxon C175 shown as Inset with Tutti Twist & Spray tap in Regency Copper - see page 169



Saxon 70/30 low bowl divide
Ref. SAX C175 White **£849**
Installation: Inset/Undermount
Overall size: 840/460/240 mm
Bowl size: 440/390/210 mm
.75 bowl: 315/390/210 mm
Minimum cabinet size: 900 mm
Overflow: No
Tap-holes: No

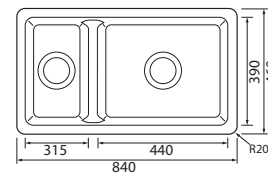

Saxon C175 shown as Undermount

Standard Wastes



Stainless
W90C £24

Optional Coloured Wastes

1.0 Bowl = 1 x W90**
2.0 Bowl = 2 x W90**



Artisan Brass
W90AB £53



Regency Copper
W90RC £53



Gold
W90G £53



Matt Black
W90MB £53

SAXON 175



The **Saxon 175** is extremely versatile with its unique low bowl divider. Everyday washing tasks are carried out in either bowl and when larger items are to be washed, simply raise the water level to fill both bowls creating a single giant bowl. A clever design that is also an excellent water saving device. All Saxon models can be installed as Insets or Undermounts.

STAINLESS STEEL

INSET



Inset

This installation requires the sink to be mounted into the worktop from the above. This installation type is suitable for all types of worktop including laminated chipboard.

Page 74-98

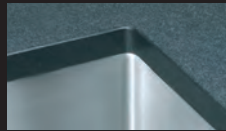

Undermount

This installation requires the sink to be fitted to the worktop from the underside. This installation type is only suitable for solid surface worktops such as Granite, Marble or Wood.

Page 100-121



Apron Front

In this installation the sink is fitted directly onto a cabinet with its front fascia exposed. This type of installation is only suitable for solid surface worktops such as Granite, Marble or Wood.

Page 122-125

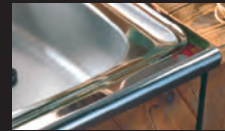

Lay-On

Fit directly on to the kitchen cabinet and are not set into a work-top, therefore maximising the wet area. Each sink is supplied with twin tap-holes for either traditional pillar taps or deck mixer style taps.

Page 99



ICONS EXPLAINED

Installation



Handing



Other Details



ICONS EXPLAINED

SilentCote®



Sinks bearing the SilentCote icon are treated with a sound absorbing thermal paint on the underside, reducing noise and increasing durability.

Pre-fitted Seal



Sinks bearing this icon come with a seal already applied to the sink so that the installer does not have to do it by hand.

Sink Finish



Brushed, Silk or Satin



PRODUCT BENEFITS

Stainless Steel remains the most popular medium for kitchen sink production. It's not difficult to realise when you consider it's main attributes:

Heat Resistant

Stainless Steel is highly heat resistant, so much so that hot pans straight from the stove can rest safely on the sink - a highly useful thing when juggling the pasta.

Hygienic

A totally non-porous surface that is easy to keep clean and consequently more hygienic.

Impact Resistant

Stainless Steel is the most forgiving material for impact and is the least likely material to damage your best china or glassware whilst remaining unscathed itself.



Dirt-repellent effect
The dirt simply runs off.



Odour-free
Leaves the surface free of smells.



Heat-proof
Not temperature sensitive.



Food-safe
Absolutely safe material.



Hygienic Surface



Made to last
Extremely durable.



Stain-resistant
Food stains cannot stick.



Impact-resistant
Tough and resistant material.



Studio Sinks Page 74 - 87



Designer Sinks Page 88 - 95



Bar Sinks Page 96 - 97



Contract Sinks Page 98 - 99

Finishes



Brushed Finish
distinctive grained finish that is ideal for matching with stainless steel appliances.

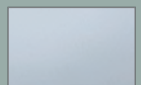

Satin Finish
even soft silk finish.

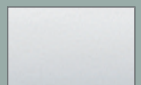

Silk Finish
lightly brushed with a brighter tone.



Verdi VE96 shown with Magus 3 Kettle tap in Chrome - see page 134-135

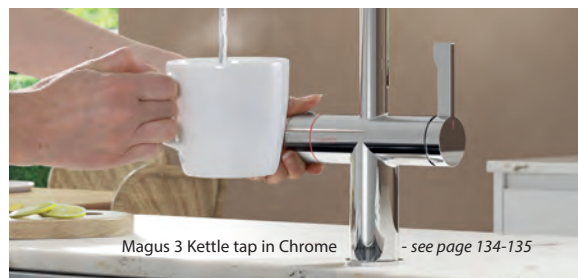

Magus 3 Kettle tap in Chrome - see page 134-135

VERDI



The **Verdi** is our latest economically priced range of sinks offering modern design and assured quality at a great price. Choose from three models; two single bowls one of which has a capacious washing bowl (see illustration) making it an ideal choice for cleaning big pots and oven trays. Then there is of course the ever versatile 1.5 bowl model which still remains the most popular model in the UK.



Verdi Single bowl and drainer

Ref. VE80 £115
 Overall size: 965/500 mm
 Bowl size: 340/400/170 mm
 Cutout size: 780/480 mm
 Minimum cabinet size: 450 mm
 Waste included: 90 mm BSW



Verdi Large bowl and drainer

Ref. VE96 £135
 Overall size: 965/500 mm
 Bowl size: 440/400/170 mm
 Cutout size: 945/480 mm
 Minimum cabinet size: 600 mm
 Waste included: 90 mm BSW



Verdi 1.5 bowl and drainer

Ref. VE150 £145
 Overall size: 965/500 mm
 Bowl size: 340/400/170 mm
 Half bowl: 160/300/101 mm
 Cutout size: 945/480 mm
 Minimum cabinet size: 600 mm
 Waste included: 2 x 90 mm BSW & Plumbing Kit

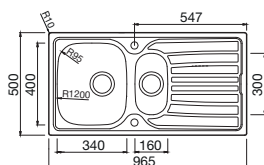
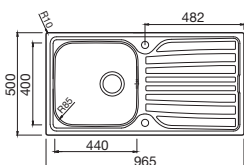
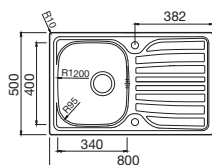

STARLINE



The **Starline** has stylish design features reinforcing its designer credentials. There are two bowl options available, offering distinctly different solutions for the kitchen. The ever useful 1.5 bowl offers multi-task capabilities and the particularly capacious single bowl model will tackle the biggest of jobs with ease.

Starline SL150 shown with Titania T1255 Stainless Steel tap - see page 202



Starline Large bowl and drainer

Ref. SL100 £185
 Overall size: 1000/500 mm
 Bowl size: 465/415/215 mm
 Cutout size: 980/480 mm
 Minimum cabinet size: 600 mm
 Waste included: 90 mm BSW



Starline 1.5 bowl and drainer

Ref. SL150 £205
 Overall size: 1000/500 mm
 Bowl size: 350/415/190 mm
 Half bowl: 160/285/120 mm
 Cutout size: 980/480 mm
 Minimum cabinet size: 600 mm
 Waste included: 2 x 90 mm BSW & Plumbing Kit

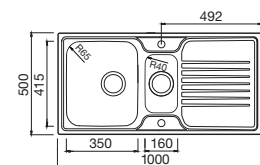
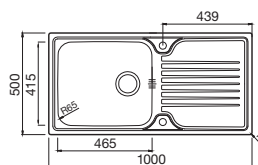



AVA



The **Ava** has a distinctive narrow 8-rib drainer pattern which provides excellent draining qualities that not only look smart but has the added benefit of increasing the Ava's overall tensile strength. All models have been treated to Silencote to add the robust and acoustic qualities.

These economic trio offer versatility and excellent value for money.

Ava 150 shown with Morpho Brushed Nickel tap with flex and stay spout - see page 176-177



Bolero BO150 shown with Zuben Stainless Steel Filter tap - see page 159

BOLERO



The **Bolero** family of sinks offer super value for money. The three bowl configuration alternatives provide lots of design flexibility and each sink is manufactured in 0.6mm thick steel and finished in a satin finish that will ensure a long lasting smart appearance.



Ava Single bowl and drainer
Ref. AV86 £120

Overall size: 860/500 mm
Bowl size: 340/400/160 mm
Cutout size: 840/480 mm
Minimum cabinet size: 450 mm
Waste included: 90 mm BSW

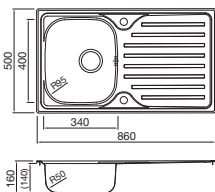

Ava Large bowl and drainer
Ref. AV100 £135

Overall size: 1000/500 mm
Bowl size: 400/400/160 mm
Cutout size: 980/480 mm
Minimum cabinet size: 500 mm
Waste included: 90 mm BSW

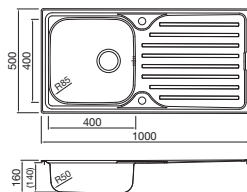

Ava 1.5 bowl and drainer
Ref. AV150 £150

Overall size: 1000/500 mm
Bowl size: 340/400/160 mm
Half bowl: 160/300/91 mm
Cutout size: 980/480 mm
Minimum cabinet size: 600 mm
Waste included: 2 x 90 mm BSW & Plumbing Kit

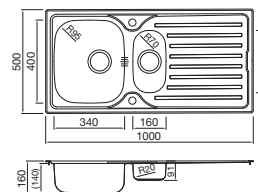

Bolero Single bowl and drainer
Ref. BO90 £139

Overall size: 860/500 mm
Bowl size: 345/395/160 mm
Cutout size: 840/480 mm
Minimum cabinet size: 450 mm
Waste included: 90 mm BSW

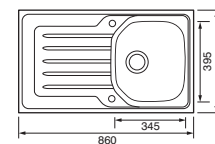

Bolero Large bowl and drainer
Ref. BO100 £147

Overall size: 1000/500 mm
Bowl size: 450/395/160 mm
Cutout size: 980/480 mm
Minimum cabinet size: 600 mm
Waste included: 90 mm BSW

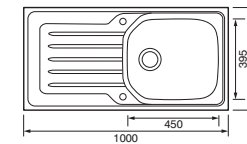

Bolero 1.5 bowl and drainer
Ref. BO150 £202

Overall size: 1000/500 mm
Bowl size: 345/395/160 mm
Half bowl: 170/320/80 mm
Cutout size: 980/480 mm
Minimum cabinet size: 600 mm
Waste included: 2 x 90 mm BSW & Plumbing Kit

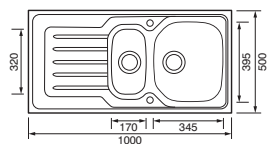

Icons Explained see page 72-73



Indio IN200 shown with Juno Chrome tap - see page 172



Indio IN150 shown with Titania Stainless Steel tap - see page 202





INDIO



The **Indio** offers a wide choice of bowl options to cater for every possible kitchen demand. All models share the same distinctive linear styling that will be suitable for both contemporary and retro kitchen settings.

Juno Chrome

Karuma Chrome

Titania SS



Indio IN86 shown with Karuma Pull-out tap in Chrome - see page 190



Indio Single bowl and drainer
Ref. IN86 £160
 Overall size: 860/500 mm
 Bowl size: 350/415/195 mm
 Cutout size: 840/480 mm
 Minimum cabinet size: 500 mm
 Waste included: 90 mm BSW

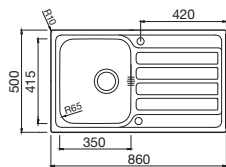

Indio Large bowl and drainer
Ref. IN100 £185
 Overall size: 1000/500 mm
 Bowl size: 465/415/220 mm
 Cutout size: 980/480 mm
 Minimum cabinet size: 600 mm
 Waste included: 90 mm BSW

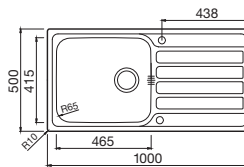

Indio 1.5 bowl and drainer
Ref. IN150 £205
 Overall size: 1000/500 mm
 Bowl size: 350/415/195 mm
 Half bowl: 160/285/120 mm
 Cutout size: 980/480 mm
 Minimum cabinet size: 600 mm
 Waste included: 2 x 90 mm BSW & Plumbing Kit

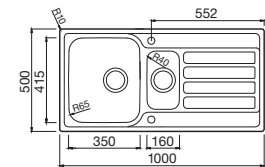

Indio Double bowl and drainer
Ref. IN200 £230
 Overall size: 1160/500 mm
 Bowl sizes: 350/415/195 mm
 Cutout size: 1140/480 mm
 Minimum cabinet size: 900 mm
 Waste included: 2 x 90 mm BSW & Plumbing Kit

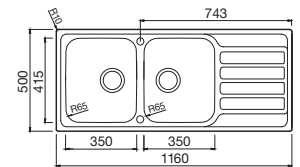

Icons Explained see page 72-73



DEEP BLUE



Three solidly constructed sinks with star-burst drainer patterns that offer a cheerful feel to your kitchen. Manufactured from 0.8 gauge 18/10 stainless steel which also benefits from **SilentCote®**, a special sound-proofing under-coat paint which further adds to the Deep Blue's durability.

Optional Accessories



Ref. **DSO4** (DB5 & 15)
Stainless Steel Basket
with plate rack **£46**

Deep Blue DB15B shown with
Porrina Pull-out tap in Chrome - see page 193



Deep Blue Single bowl and drainer
Ref. **DB5B** **£190**

Overall size: 800/500 mm
Bowl size: 350/410/200 mm
Cutout size: 780/480 mm
Minimum cabinet size: 450 mm
Waste included: 90 mm BSW

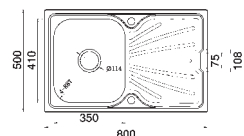

Deep Blue Large bowl and drainer
Ref. **DB10** Brushed **£235**

Overall size: 1000/500 mm
Bowl size: 480/400/220 mm
Cutout size: 980/480 mm
Minimum cabinet size: 600 mm
Waste included: 90 mm BSW

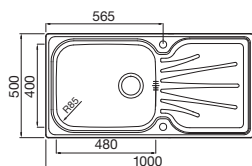

Deep Blue 1.5 bowl and drainer
Ref. **DB15** Brushed **£239**

Overall size: 1000/500 mm
Bowl size: 332/400/190 mm
Half bowl: 162/300/115 mm
Cutout size: 980/480 mm
Minimum cabinet size: 600 mm
Waste included: 2 x 90 mm BSW & Plumbing Kit

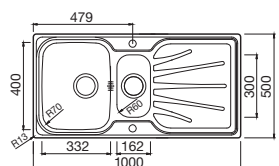

Kudos KU790 shown with Karuma Pull-out tap in Chrome - see page 190

KUDOS



The competitively priced **Kudos** has bold design elements not usually found on eco-priced sinks. Amongst its group of three is a useful double bowl model that is ideal for a multi-tasking.



Kudos Small bowl and drainer
Ref. **KU790** **£175**

Overall size: 790/500 mm
Bowl size: 340/380/160 mm
Cutout size: 770/480 mm
Minimum cabinet size: 450 mm
Waste included: 90 mm BSW

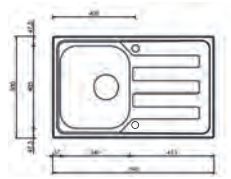

Kudos 1.5 bowl and drainer
Ref. **KU150** **£210**

Overall size: 1000/500 mm
Bowl size: 340/380/160 mm
Half bowl: 170/330/100 mm
Cutout size: 975/490 mm
Minimum cabinet size: 600 mm
Waste included: 90 mm BSW & Plumbing Kit

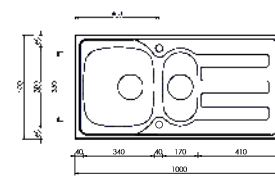

Kudos Double bowl and drainer
Ref. **KU200** **£220**

Overall size: 1160/500 mm
Bowl sizes: 340/405/170 mm
Cutout size: 1135/475 mm
Minimum cabinet size: 800 mm
Waste included: 2 x 90 mm BSW & Plumbing Kit

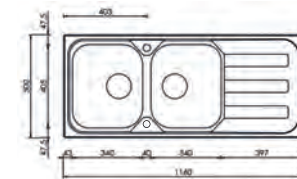

Icons Explained see page 72-73









Okio small shown with Creta tap in Chrome - see page 185



Okio 1.5 bowl shown with Juno tap in Chrome - see page 172

OKIO







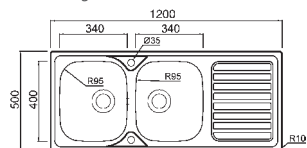

The **Okio** range offers great practicality with contemporary styling, there are six options including a really useful double bowl model - ideal for high use kitchens. All models are manufactured from 0.6mm gauge stainless steel and can be fitted as left or right hand drainers.

SINKS STAINLESS STEEL INSET



Okio Double bowl and drainer
Ref. 7510823 £303
 Overall size: 1200/500 mm
 Bowl sizes : 340/400/160 mm
 Cutout size: 1176/476 mm
 Minimum cabinet size: 800 mm
 Waste included: 2 x 90 mm BSW & Plumbing Kit



Okio 1.5 bowl and drainer
Ref. 7510423 £280
 Overall size: 1000/500 mm
 Bowl size: 340/400/160 mm
 Half bowl: 160/350/90 mm
 Cutout size: 976/476 mm
 Minimum cabinet size: 600 mm
 Waste included: 2 x 90 mm BSW & Plumbing Kit

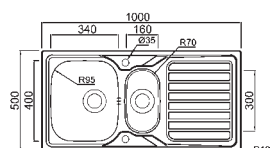

Okio Large bowl and drainer
Ref. 7510723 £228
 Overall size: 1000/500 mm
 Bowl size: 450/400/160 mm
 Cutout size: 976/476 mm
 Minimum cabinet size: 500 mm
 Waste included: 90 mm BSW

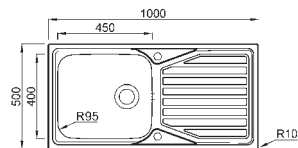

Okio Single bowl and drainer
Ref. 7507123 £180
 Overall size: 860/500 mm
 Bowl size: 340/400/160 mm
 Cutout size: 836/476 mm
 Minimum cabinet size: 450 mm
 Waste included: 90 mm BSW

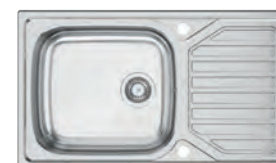
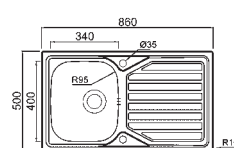

Okio Large bowl and small drainer
Ref. OK86L £180
 Overall size: 860/500 mm
 Bowl size: 450/400/160 mm
 Cutout size: 836/476 mm
 Minimum cabinet size: 500 mm
 Waste included: 90 mm BSW

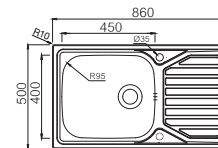

Okio Small bowl & drainer
Ref. 7510223 £195
 Overall size: 650/500 mm
 Cutout size: 630/480 mm
 Bowl depth: 160 mm
 Minimum cabinet size: 450 mm
 Waste included: 90mm BSW

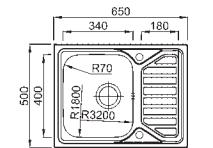

VIVA



The **Viva's** most notable features include three bold drainer panels and a slim-edge profile that creates a near flush setting with the work surface. Three bowl options include a catering-size single bowl and a compact version for the smaller kitchen and not forgetting the indispensable 1.5 bowl also playing its role.



Viva V1151 shown with Juno tap in Chrome - see page 172



Monza MN150 shown with Magus 3 Kettle tap in Chrome - see page 134-135



MONZA



The **Monza's** sharper radius bowls are complimented by unique drainer channels that provide rather a dynamic aesthetic. The Monza collection offer three bowl options that should fulfil most busy kitchen demands, particularly the 'workhorse' double-bowl option.



Viva Single bowl and drainer
Ref. V1870 £350
 Overall size: 870/510 mm
 Bowl size: 342/410/210 mm
 Cutout size: 850/490 mm
 Minimum cabinet size: 450 mm
 Waste included: 90 mm BSW

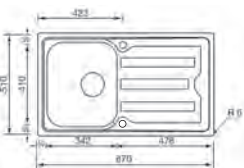

Viva Large bowl and drainer
Ref. V1101 £395
 Overall size: 1010/510 mm
 Bowl size: 500/400/210 mm
 Cutout size: 990/490 mm
 Minimum cabinet size: 600 mm
 Waste included: 90 mm BSW

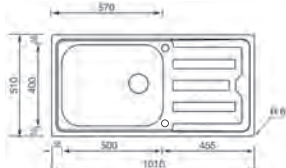

Viva 1.5 bowl and drainer
Ref. V1151 £405
 Overall size: 1010/510 mm
 Bowl size: 342/410/210 mm
 Half bowl: 145/335/130 mm
 Cutout size: 990/490 mm
 Minimum cabinet size: 600 mm
 Waste included: 90 mm BSW & Plumbing Kit

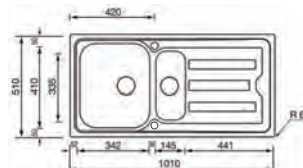

Monza Single bowl and drainer
Ref. MN860 £340
 Overall size: 860/500 mm
 Bowl size: 340/400/210 mm
 Cutout size: 835/475 mm
 Minimum cabinet size: 450 mm
 Waste included: 90 mm BSW

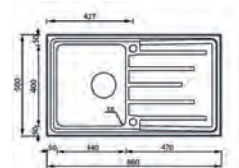

Monza 1.5 bowl and drainer
Ref. MN150 £379
 Overall size: 1000/500 mm
 Bowl size: 340/400/210 mm
 Half bowl: 145/335/140 mm
 Cutout size: 975/475 mm
 Minimum cabinet size: 600 mm
 Waste included: 90 mm BSW & Plumbing Kit

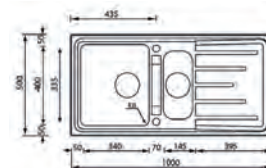

Monza Double bowl and drainer
Ref. MN200 £445
 Overall size: 1160/500 mm
 Bowl size: 340/400/210 mm
 Cutout size: 1135/475 mm
 Minimum cabinet size: 800 mm
 Waste included: 90 mm BSW & Plumbing Kit

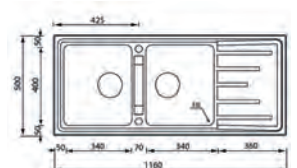

Icons Explained see page 72-73



Cresta CR100 shown with Magus 3 Kettle tap in Chrome - see page 134-135



Solar SO150L shown with Juno tap in Chrome - see page 172



Cresta Large bowl and drainer

Ref. CR100 £310
 Overall size: 1000/500 mm
 Bowl size: 500/400/210 mm
 Cutout size: 975/475 mm
 Minimum cabinet size: 600 mm
 Waste included: 90 mm BSW

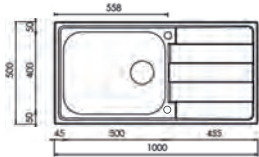

CRESTA

The **Cresta** offers four practical sink choices including a capacious single bowl with catering scale proportions. All models feature stylish drainer architecture and have slightly squarer bowl shapes that reinforce the Cresta's smart modernity.



Cresta Single bowl and drainer

Ref. CR860 £250
 Overall size: 860/500 mm
 Bowl size: 342/410/210 mm
 Cutout size: 835/475 mm
 Minimum cabinet size: 450 mm
 Waste included: 90 mm BSW

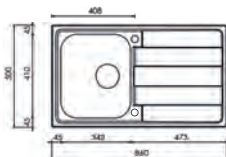

Cresta 1.5 bowl and drainer

Ref. CR150 £320
 Overall size: 1000/500 mm
 Bowl size: 342/410/210 mm
 Half bowl: 145/335/130 mm
 Cutout size: 975/475 mm
 Minimum cabinet size: 600 mm
 Waste included: 90 mm BSW & Plumbing Kit

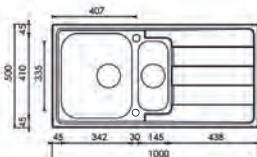

Cresta Double bowl and drainer

Ref. CR200 £330
 Overall size: 1160/500 mm
 Bowl sizes: 342/410/210 mm
 Cutout size: 1135/475 mm
 Minimum cabinet size: 800 mm
 Waste included: 2 x 90 mm BSW & Plumbing Kit

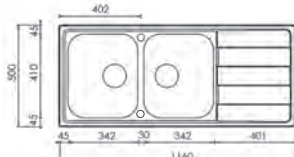

SOLAR



This elegant sink range has been designed with smart understated features that ooze class. Sharp corners symmetrical draining flutes and robust engineering ensure enduring good looks.



Juno tap in Chrome - see page 172



Solar Single bowl and drainer

Ref. SO86L LH Drainer £305
Ref. SO86R RH Drainer £305
 Overall size: 860/500 mm
 Bowl size: 350/400/215 mm
 Cutout size: 840/480 mm
 Minimum cabinet size: 600 mm
 Waste included: 90 mm BSW

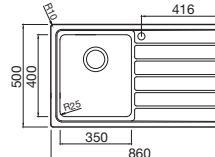

Solar Single bowl and drainer

Ref. SO100L LH Drainer £325
Ref. SO100R RH Drainer £325
 Overall size: 1000/500 mm
 Bowl size: 450/400/215 mm
 Cutout size: 980/480 mm
 Minimum cabinet size: 600 mm
 Waste included: 90 mm BSW

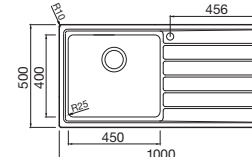

Solar 1.5 bowl and drainer

Ref. SO150L LH Drainer £355
Ref. SO150R RH Drainer £355
 Overall size: 1000/500 mm
 Bowl size: 350/400/215 mm
 Half bowl: 180/300/135 mm
 Cutout size: 980/480 mm
 Minimum cabinet size: 600 mm
 Waste included: 2 x 90 mm BSW & Plumbing Kit

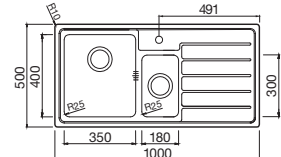

Icons Explained see page 72-73



Xeron 100 shown with Mariner Filter tap in Brushed Nickel - see pages 144-145

XERON



These sophisticated hand finished sinks are our most geometrically shaped models and have been planned with aesthetics and practicality in mind. They are manufactured using only the highest quality 1.2mm stainless steel and have been brush polished resulting in a lustrous grained finish. There are four different configurations including a double drainer model which is ideal for particularly high use kitchens.

Optional Accessories



Ref. 04521
Stainless Steel Colander £195



Xeron 86 Single bowl and drainer
Ref. MH1F143A2 LHD £633
Ref. MH1F243A2 RHD £633
Overall size: 860/520 mm
Bowl size: 400/400/200 mm
Cutout size: 842/502 mm
Minimum cabinet size: 500 mm
Waste included: 90 mm BSW

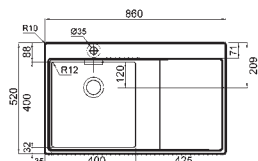

Xeron B50 Single bowl and double drainer
Ref. MO1F443A2 £800
Overall size: 1160/520 mm
Bowl size: 500/400/200 mm
Cutout size: 1142/502 mm
Minimum cabinet size: 600 mm
Waste included: 90 mm BSW

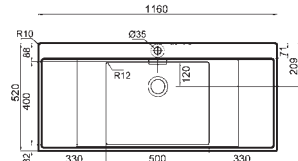

Xeron 105 Large bowl and drainer
Ref. ML1F143A2 LHD £693
Ref. ML1F243A2 RHD £693
Overall size: 1000/520 mm
Bowl size: 500/400/200 mm
Cutout size: 982/502 mm
Minimum cabinet size: 600 mm
Waste included: 90 mm BSW

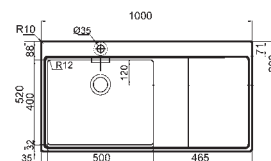

Xeron 100 1.5 bowl and drainer
Ref. ML7F148A2 LHD £851
Ref. ML4F128A2 RHD £851
Overall size: 1000/520 mm
Bowl size: 340/400/200 mm
Half bowl: 170/400/170 mm
Cutout size: 982/502 mm
Minimum cabinet size: 600 mm
Waste included: 2 x 90 mm BSW & Plumbing Kit

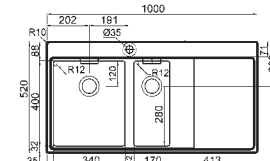



Zenith ZE100R shown with Titania TI2SS Stainless Steel tap - see page 202



Zenith Single bowl and drainer
Ref. ZE100L LH Drainer **£548**
Ref. ZE100R RH Drainer **£548**
 Overall size: 920/510 mm
 Bowl size: 440/415/205 mm
 Cutout size: 902/492 mm
 Minimum cabinet size: 500 mm
 Pop-up waste included: 90 mm BSW

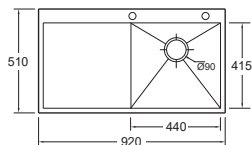

Zenith 1.5 bowl and drainer
Ref. ZE150L LH Drainer **£597**
Ref. ZE150R RH Drainer **£597**
 Overall size: 1000/510 mm
 Bowl size: 365/415/205 mm
 Half bowl: 180/415/150 mm
 Cutout size: 982/492 mm
 Minimum cabinet size: 700 mm
 Pop-up waste included: 2 x 90 mm BSW & Plumbing Kit

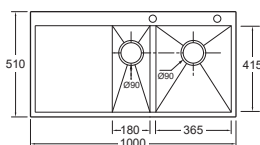

Optional Accessories



Ref. WBD433
 Wooden Chopping Board **£37**



Ref. COL415
 Stainless Steel Colander **£120**
 Fits all bowls



Ref. TR415
 Stainless Steel Tray **£46**
 Fits all bowls



Zenith ZE150R shown with Titania TI2SS Stainless Steel tap - see page 202

ZENITH



The **Zenith** sinks radiate cool minimalism with strong geometric lines. This family of sinks offer deeply recessed flat drainers that are sloped for easy drain-off. The omission of draining ribs compliment the sharp radii corners and maximise the useable work surface and offer easy to wipe down surfaces. The unusually strong construction has been made possible by using the highest quality 1.6mm thick steel which has been brushed to create a beautiful grained sheen. To further add to this sink's credentials all models have been treated with **SilentCote®** a thermal soundproofing paint.

Presto Automatic Waste - Included with the Zenith





Urban UR660 shown with Zuben Stainless Steel filter tap - see page 159

URBAN



The **Urban** are a very slick range of sinks, the bowls feature 10mm radius corners and smart draining lines enhancing their crisp architectural appearance.

The sinks are manufactured in a 1.2mm steel which has been further reinforced with **SilentCote®**, a special sound-proofing thermal paint (see page 63).

Optional Accessories



Ref. **WBD426**
Wooden Chopping Board **£37**



Ref. **RM2000** Stainless Steel Draining Mat (round bar) **£59**

Ref. **DR3000** Stainless Steel Draining Mat (square bar) **£59**
see page 113



Urban UR660 shown here with Bellatrix Professional Filter tap - see page 150



10mm corners



Flat edge profile



Urban Single bowl
Ref. **UR440** **£354**

Overall size: 440/510 mm
Bowl size: 400/400/200 mm
Minimum cabinet size: 500 mm
Waste included: 90 mm BSW

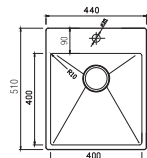

Urban Single bowl
Ref. **UR540** **£376**

Overall size: 540/510 mm
Bowl size: 500/400/200 mm
Minimum cabinet size: 600 mm
Waste included: 90 mm BSW

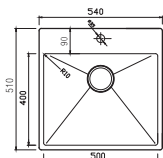

Urban Single bowl
Ref. **UR660** **£465**

Overall size: 660/515 mm
Bowl size: 610/400/200 mm
Minimum cabinet size: 800 mm
Waste included: 90 mm BSW

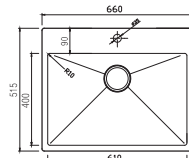

Urban 1.75 bowl
Ref. **UR810** **£713**

Overall size: 810/450 mm
Bowl size: 400/400/200 mm
.75 bowl: 330/350/200 mm
Minimum cabinet size: 900 mm
Waste included: 2 x 90 mm BSW & Plumbing Kit

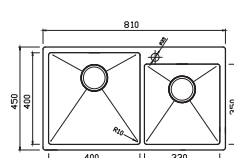

Urban UR810 shown with Auriga Pull-out tap in Chrome/Nero - see page 195



Urban Smart Ref UCS004 shown with Rosetta Filter tap in Brushed Nickel - see page 146



Urban Smart Single bowl
Ref. UCS001 £531

Overall size: 440/520 mm
Bowl size: 380/370/220 mm
Cutout size: 420/500 mm
Minimum cabinet size: 500 mm
Waste included: 90 mm BSW

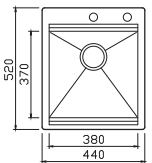

Urban Smart Single bowl
Ref. UCS002 £560

Overall size: 540/520 mm
Bowl size: 480/370/220 mm
Cutout size: 520/500 mm
Minimum cabinet size: 600 mm
Waste included: 90 mm BSW

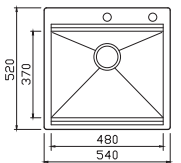

Urban Smart Single bowl
Ref. UCS003 £592

Overall size: 660/520 mm
Bowl size: 600/370/220 mm
Cutout size: 640/500 mm
Minimum cabinet size: 700 mm
Waste included: 90 mm BSW

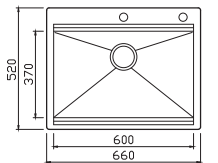

Urban Smart Single bowl
Ref. UCS004 £670

Overall size: 800/520 mm
Bowl size: 740/370/220 mm
Cutout size: 780/500 mm
Minimum cabinet size: 800 mm
Waste included: 90 mm BSW

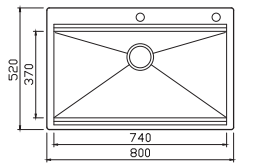

Urban Smart Ref UCS003 shown with Rosetta Filter tap in Brushed Nickel - see page 146

ACCESSORIES Included



Ref. WBD426
Wooden Chopping Board

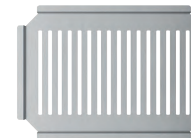

Ref. DB04
Stainless Steel Tray



Presto Automatic Waste

ACCESSORIES Optional



Ref. COL101
Stainless Steel Colander £120

URBAN SMART



The **Urban Smart** sinks are the perfect cook's assistant – custom-fit accessories including strainer colanders and trays can rest on the double-level bowl ledges freeing up hands for food prep tasks such as rinsing vegetables and straining pasta. The top ledge is used for the sliding wooden chopping board and the lower ledge is for the strainer accessories that can also slide for optimum positioning. These bespoke accessories included with the sink truly maximize the Urban Smart's abilities.

The tap-hole employed by the Presto Automatic Waste control can be made available for a secondary tap such as a Filter/Kettle tap or soap dispenser by requesting a manual waste instead of an automatic.



BELLA



The **Bella** boasts a generous size half bowl and has a sharp flat profile edge which appears almost flush to the worktop.



Bella 1.5 bowl
Ref. BE625 £332
 Overall size: 625/520 mm
 Bowl size: 340/400/185 mm
 Half bowl: 180/396/120 mm
 Cutout size: 610/505 mm
 Minimum cab size: 600 mm
 Waste included: 2 x 90 mm BSW & Plumbing Kit

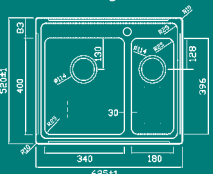

Ref. COL105
 Stainless Steel Colander **£83**
 Fits main bowl only

Bella shown with Rococo Twist & Spray tap in Chrome - see page 168

OBOE



A perfect sink if space is tight, whilst retaining a useful size washing bowl.



Oboe Single bowl and drainer
Ref. 8135 Satin £174
 Overall size: 847/444 mm
 Bowl size: 367/367/145 mm
 Cutout size: 823/420 mm R210
 Minimum cabinet size: 450 mm
 Waste included: 90 mm BSW

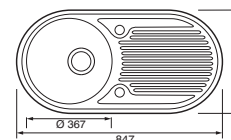

Oboe shown with Creta tap in Chrome - see page 185

SINKS STAINLESS STEEL INSET

BAR 47



The **Bar 47** sink is a great choice as an additional sink for entertaining and is also an ideal solution for mini kitchens.



Bar 47 Single bowl
Ref. BA470 £204
 Overall size: 480/480 mm
 Bowl size: 400/340/160 mm
 Cutout size: 460/460 mm
 Minimum cab size: 600 mm
 Waste included: 90 mm BSW

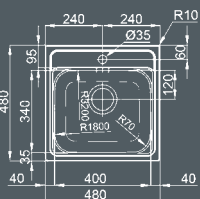

PIO BAR



Sister sink to the Bar 47 the **Pio Bar** is a little more compact, able to squeeze into the smallest installation.



Pio Bar Single bowl
Ref. PB380 £155
 Overall size: 380/380 mm
 Bowl size: 305/260/135 mm
 Cutout size: 356/356 mm
 Minimum cab size: 450 mm
 Waste included: 90 mm BSW

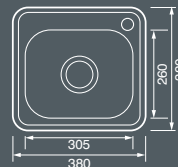

Arco Single bowl
Ref. RB450B £128
 Overall size: Ø440 mm
 Bowl size: Ø390/185 mm
 Cutout size: Ø416 mm
 Minimum cabinet size: 450 mm
 Waste included: 90 mm BSW

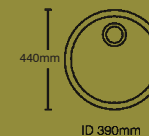

ARCO MINI



Arco Mini Single bowl
Ref. 25201 £192
 Overall size: Ø355 mm
 Bowl size: Ø305/170 mm
 Cutout size: Ø335 mm
 Minimum cab size: 350 mm
 Waste included: 60 mm BSW

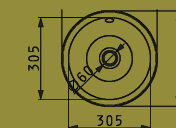

CONTRACT INSET



CONTRACT LAY-ON



Contract Lay-On fit directly on to the kitchen cabinet and are not set into a work-top, therefore maximising the wet area.

Each sink is supplied with twin tap-holes for either traditional pillar taps or deck mixer style taps.



Contract Sink shown with Venue pillar taps - see below right

CONTRACT TAPS



Venue Lever Deck Mounted Sink Mixer

Ref. DLT105
Chrome **£98**

Min 0.1 bar pressure required
Swivel Spout / Dual Flow
Mounting hole size \varnothing 2 x 28mm
WRAS Approved



Venue Modern Deck Mounted Sink Mixer

Ref. DCM105
Chrome **£88**

Min 0.1 bar pressure required
Swivel Spout / Dual Flow
Mounting hole size \varnothing 2 x 28mm
WRAS Approved



Venue Lever Sink Pillars

Ref. DLT103
Chrome **£57** (pair)

Min 0.1 bar pressure required
Mounting hole size \varnothing 28mm
WRAS Approved



Venue Modern Sink Pillars

Ref. DCM103
Chrome **£52** (pair)

Min 0.1 bar pressure required
Mounting hole size \varnothing 28mm
WRAS Approved



Shallow Bowl Suitable for wheelchair users
Ref. PH940 £186

Overall size: 950/508 mm
Bowl size: 420/350/120 mm
Cutout size: 930/488 mm
Minimum cabinet size: 500 mm
Tap hole: Reversible
Steel Gauge: 0.6 mm

Ref. WCWO Waste & Overflow **£7**

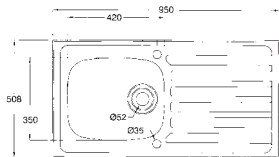

Contract Single bowl and drainer

Ref. SBSDL1 LH Drainer £100

Ref. SBSDR1 RH Drainer £100

Steel Gauge: 0.7 mm

Overall size: 940/485 mm
Bowl size: 420/345/170 mm
Cutout size: 920/465 mm
Minimum cabinet size: 500 mm
Tap hole: 1 Handed

Ref. WCWO Waste & Overflow **£7**

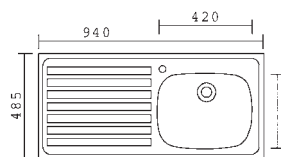

Contract Single bowl and drainer

Ref. SBSDL2 LH Drainer £100

Ref. SBSDR2 RH Drainer £100

Steel Gauge: 0.7 mm

Overall size: 940/485 mm
Bowl size: 420/345/170 mm
Cutout size: 920/465 mm
Minimum cabinet size: 500 mm
Tap hole: 2 Handed

Ref. WCWO Waste & Overflow **£7**

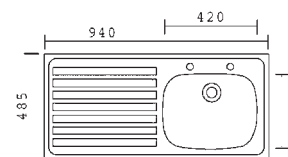

Spacesaver Single bowl and drainer

Ref. SS86RS Satin £105

Overall size: 860/435 mm
Bowl size: 340/370/150 mm
Cutout size: 836/411 mm
Minimum cabinet size: 600 mm
Waste included: 60 mm ring plug

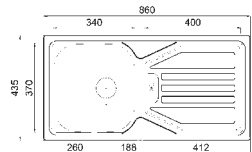

Contract Single bowl and double drainer

Ref. SBDD1 £361 1 Tap Hole

Ref. SBDD2 £361 2 Tap Holes

Overall size: 1310/510 mm

Bowl size: 400/340/160 mm
Cutout size: 1290/490 mm
Minimum cabinet size: 500 mm
Steel Gauge: 0.7 mm

Ref. WCWO Waste & Overflow **£7**

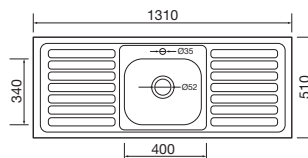

Square Front 105 Single bowl and drainer

Ref. 105SFL LH Drainer £169

Ref. 105SFR RH Drainer £169

Overall size: 1000/500 mm
Bowl size: 420/350/160 mm
Tap hole: 2 Handed
Steel Gauge: 0.6 mm
Front profile: 30 mm
Ledge: 30 mm
Centres: 180 mm

Ref. WCWO Waste & Overflow **£7**

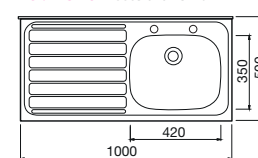

Square Front 106 Single bowl and drainer

Ref. 106SFL LH Drainer £189

Ref. 106SFR RH Drainer £189

Overall size: 1000/600 mm

Bowl size: 400/420/160 mm
Tap hole: 2 Handed
Steel Gauge: 0.6 mm

Front profile: 30 mm
Ledge: 30 mm
Centres: 180 mm

Ref. WCWO Waste & Overflow **£7**

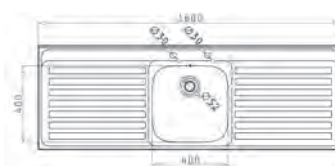
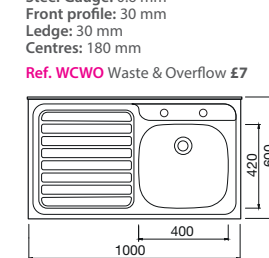

Square Front Single bowl and double drainer

Ref. 63DDSF £299

Overall size: 1600/543 mm
Bowl size: 400/400/155 mm
Tap hole: 2
Steel Gauge: 0.7 mm

Ref. WCWO Waste & Overflow **£7**

UNDERMOUNT

We offer a huge choice of stainless steel undermount sinks, from soft form to zero radius bowls and compact to capacious; you can be assured you will find the perfect solution for your needs. Also, amongst the undermount pages you will see our Smart series which offer fitted accessories to broaden versatility.



This installation requires the sink to be fitted to the worktop from the underside. This installation type is only suitable for solid surface worktops such as Granite, Marble or Wood.



Vortex VO850 shown with Juno tap in Chrome - see page 172



Vortex VO850 shown with Auriga Pull-out tap in Chrome/Black - see page 195

SINKS STAINLESS STEEL UNDERMOUNT



Vortex Single bowl and drainer
Ref. VO850 £480
 Overall size: 850/440 mm
 Bowl size: 405/400/190 mm
 Cutout size: Template Available
 Minimum cabinet size: 1000 mm
 Waste included: 90 mm BSW

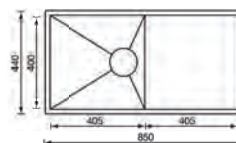

Vortex Large bowl and drainer
Ref. VO990 £505
 Overall size: 990/440 mm
 Bowl size: 475/400/190 mm
 Cutout size: Template Available
 Minimum cabinet size: 1200 mm
 Waste included: 90 mm BSW

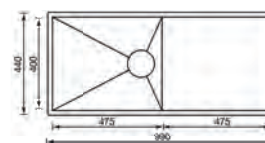

VORTEX UNDERMOUNT



The **Vortex** is the next generation of undermount sinks combining a bowl with a drainer. This is a perfect solution for those who want the modernity and sleek looks that undermounts provide but want to avoid using the worktop as a drying area. This is a single-piece handcrafted sink that sits beautifully beneath a solid surface worktop offering sophistication and practicality.



Jazz Single bowl
Ref. JA014 £248
 Overall size: 380/440 mm
 Bowl size: 340/400/190 mm
 Min cabinet size: 400 mm

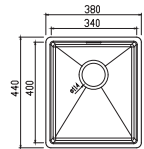

JAZZ UNDERMOUNT/INSET



The **Jazz** offers amazing value for money when you consider its excellent credentials. Constructed from a robust 1.0mm stainless steel and treated with **SilentCote®** for added hushed tones when in use. Fine radius corners for an ultra-contemporary aesthetic, a brushed grained finish with smart draining lines on the bowl floor to aid rapid draining.

The decorative graining extends to the normally unseen rim which means all models can be installed in both undermount and inset formats as well.

Optional Accessories



Ref. COL103
 Stainless Steel Colander **£120**



Ref. COL105
 Stainless Steel Colander **£83**



Ref. RM2000 Stainless Steel Draining Mat (round bar) **£59**

Ref. DR3000 Stainless Steel Draining Mat (square bar) **£59**



Jazz JA021RH shown with Titania TI2SS StainlessSteel tap - see page 202



Jazz Single bowl
Ref. JA012 £274
 Overall size: 450/440 mm
 Bowl size: 410/400/190 mm
 Min cabinet size: 450 mm

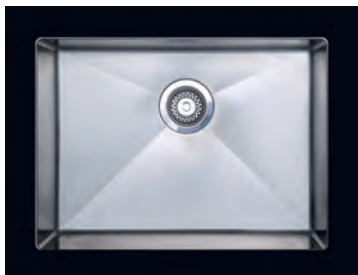
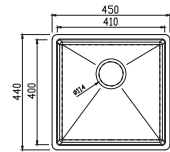

Jazz Single bowl
Ref. JA013 £314
 Overall size: 590/440 mm
 Bowl size: 550/400/190 mm
 Min cabinet size: 600 mm

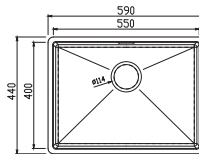

90mm Strainer Wastes included with all sinks



Plumbing Kit included with multi-bowl sinks



Deluxe Strainer Waste (upgrade) Chrome **£20** Brushed **£32**

Undermount Cutouts DXF drawings are available for download.



Jazz Double bowl
Ref. JA024 £500
 Overall size: 750/440 mm
 Bowl sizes: 340/400/190 mm
 Minimum cabinet size: 800 mm

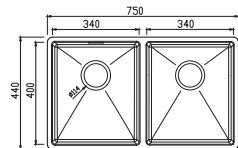

Jazz 1.5 bowl
Ref. JA022LH LH Main Bowl **£500**
Ref. JA022RH RH Main Bowl **£500**
 Overall size: 800/440 mm
 Bowl size: 550/400/190 mm
 Half bowl: 180/400/125 mm
 Minimum cabinet size: 800 mm

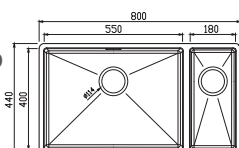

Jazz 1.5 bowl
Ref. JA021LH LH Main Bowl **£477**
Ref. JA021RH RH Main Bowl **£477**
 Overall size: 660/440 mm
 Bowl size: 410/400/190 mm
 Half bowl: 180/400/125 mm
 Minimum cabinet size: 700 mm

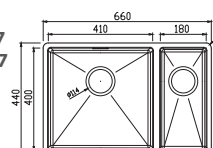

Jazz 1.5 bowl
Ref. JA023LH LH Main Bowl **£465**
Ref. JA023RH RH Main Bowl **£465**
 Overall size: 590/440 mm
 Bowl size: 340/400/190 mm
 Half bowl: 180/400/125 mm
 Min cabinet size: 600 mm

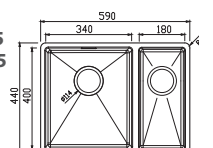

Icons Explained see page 72-73

SALSA UNDERMOUNT



The **Salsa** are a mid-priced range of undermounts with smart contemporary styling, with 25mm radius corners and are constructed from 0.8mm steel. All Salsa sinks are coated with **SilentCote®** sound-proofing thermal paint (see page 73).

There are five double bowl and five single bowl models to choose from - all of which can be mixed and matched to create the perfect sink solution.



Optional Accessories



Ref. COL103
Stainless Steel Colander £120



Ref. COL105
Stainless Steel Colander £83



Ref. RM2000 Stainless Steel Draining Mat (round bar) £59
Ref. DR3000 Stainless Steel Draining Mat (square bar) £59



Salsa 1.5 bowl
Ref. SA60L LH Main Bowl £496
Ref. SA60R RH Main Bowl £496

Overall size: 600/450 mm
Bowl size: 340/400/180 mm
Half bowl: 180/396/120 mm
Minimum cabinet size: 600 mm

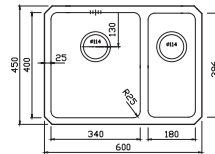

Salsa 1.5 bowl
Ref. SA74L LH Main Bowl £539
Ref. SA74R RH Main Bowl £539

Overall size: 740/450 mm
Bowl size: 480/400/195 mm
Half bowl: 180/396/120 mm
Minimum cabinet size: 800 mm

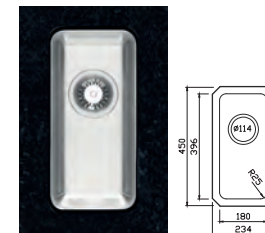
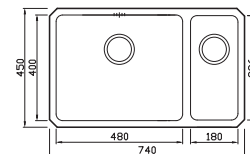

Salsa Single bowl
Ref. SA20 £194

Overall size: 234/450 mm
Bowl size: 180/396/120 mm
Minimum cabinet size: 300 mm

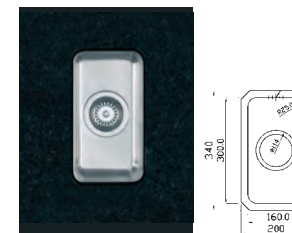

Salsa Half bowl
Ref. SA16 £222

Overall size: 200/340 mm
Bowl size: 160/300/120 mm
Minimum cabinet size: 300 mm



Salsa SA74L shown with Tutti Twist & Spray tap in Chrome - see page 169



Salsa 1.5 bowl
Ref. SA90L LH Main Bowl £559
Ref. SA90R RH Main Bowl £559

Overall size: 910/450 mm
Bowl size: 650/400/200 mm
Half bowl: 180/396/120 mm
Minimum cabinet size: 1000 mm

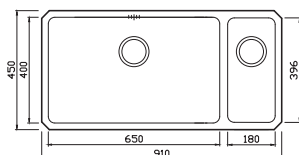

Salsa 1.5 bowl
Ref. SA53L LH Main Bowl £485
Ref. SA53R RH Main Bowl £485

Overall size: 580/450 mm
Bowl size: 340/400/190 mm
Half bowl: 160/300/120 mm
Minimum cabinet size: 600 mm

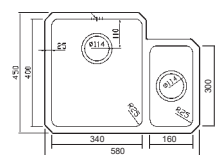

Salsa Double bowl
Ref. SA77 £539

Overall size: 760/450 mm
Bowl sizes: 340/400/190 mm
Minimum cabinet size: 800 mm

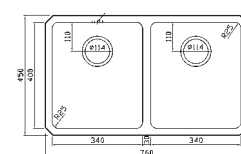

Salsa Single bowl
Ref. SA65 £463

Overall size: 700/450 mm
Bowl size: 650/400/200 mm
Minimum cabinet size: 800 mm

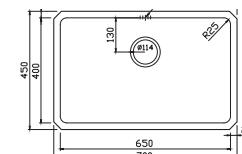

Salsa Single bowl
Ref. SA48 £371

Overall size: 530/450 mm
Bowl size: 480/400/200 mm
Minimum cabinet size: 600 mm

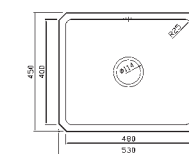

Salsa Single bowl
Ref. SA34 £305

Overall size: 390/450 mm
Bowl size: 340/400/190 mm
Minimum cabinet size: 400 mm

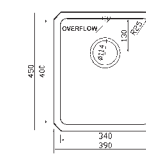

90mm Strainer Wastes included with all sinks



Plumbing Kit included with multi-bowl sinks



Deluxe Strainer Waste (upgrade) Chrome £20
Brushed £32

Undermount Cutouts DXF drawings are available for download.



Tango SP500 shown with Juno tap in Chrome - see page 172



TANGO UNDERMOUNT



The softer corners of the Tango Undermounts offer a more traditional aesthetic. There are an abundance of sizes and bowl configurations to choose from, so you can create the ideal sink solution for your kitchen. All models benefit from **SilentCote®** soundproofing that also add to the sinks' robust character.

SINKS STAINLESS STEEL UNDERMOUNT



Tango 1.5 bowl
Ref. SP20 £260
Overall size: 594/460 mm
Bowl size: 350/410/185 mm
Half bowl: 164/300 mm
Minimum cabinet size: 600 mm

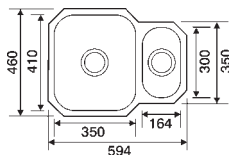

Tango Single bowl
Ref. SP164 £70
Overall size: 204/340 mm
Bowl size: 164/300/100 mm
Min cabinet size: 300 mm

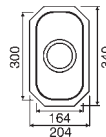

Tango Single bowl
Ref. SP350 £140
Overall size: 340/400 mm
Bowl size: 290/350/165 mm
Minimum cabinet size: 400 mm

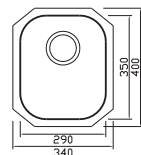

Tango Single bowl
Ref. SP410 £190
Overall size: 440/385 mm
Bowl size: 410/355/180 mm
Minimum cabinet size: 450 mm

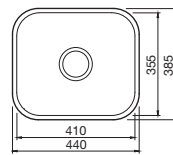

Tango Single bowl
Ref. SP400 £180
Overall size: 446/440 mm
Bowl size: 406/406/180 mm
Minimum cabinet size: 450 mm

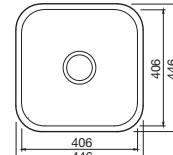

Tango Single bowl
Ref. SP480 £240
Overall size: 530/450 mm
Bowl size: 480/400/195 mm
Minimum cabinet size: 600 mm

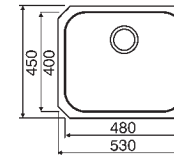

Tango Single bowl
Ref. SP500 £260
Overall size: 533/433 mm
Bowl size: 500/400/200 mm
Minimum cabinet size: 600 mm

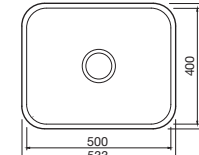

90mm Strainer Wastes
included with all sinks



Plumbing Kit
included with multi-bowl sinks



Deluxe Strainer Waste
(upgrade)
Chrome £20
Brushed £32

Undermount Cutouts
DXF drawings are available for download.



Optional Accessories



Ref. COL103
Stainless Steel Colander £120



Ref. COL105
Stainless Steel Colander £83



Ref. RM2000 Stainless Steel Draining Mat (round bar) £59
Ref. DR3000 Stainless Steel Draining Mat (square bar) £59



STEREO UNDERMOUNT/INSET



The **Stereo** sinks are state of the art, modern and very slick with 15mm radius corners and distinctive draining lines. These high quality sinks can be fitted in undermount and inset installations. Manufactured from 1.0mm gauge stainless steel and coated with **SilentCote®** sound-proofing thermal paint on the underside (see page 73).



SINKS STAINLESS STEEL UNDERMOUNT



Stereo Single bowl
Ref. STE34 £315
Overall size: 370/430 mm
Bowl size: 340/400/200 mm
Minimum cabinet size: 400 mm

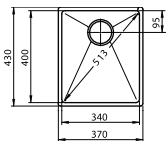

Stereo Single bowl
Ref. STE40 £360
Overall size: 430/430 mm
Bowl size: 400/400/200 mm
Minimum cabinet size: 500 mm

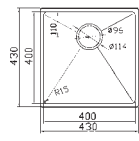

Stereo Single bowl
Ref. STE45 £380
Overall size: 480/430 mm
Bowl size: 450/400/200 mm
Minimum cabinet size: 500 mm

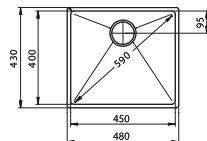

Stereo Single bowl
Ref. STE50 £400
Overall size: 530/430 mm
Bowl size: 500/400/200 mm
Minimum cabinet size: 600 mm

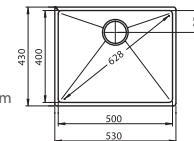

Stereo Single bowl
Ref. STE65 £480
Overall size: 680/430 mm
Bowl size: 650/400/230 mm
Minimum cabinet size: 700 mm

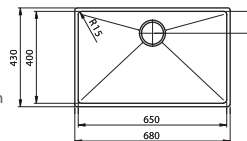

Stereo Double bowl
Ref. STE4034 £600
Overall size: 800/430 mm
Left bowl: 340/400/200 mm
Right bowl: 400/400/200 mm
Minimum cabinet size: 850 mm

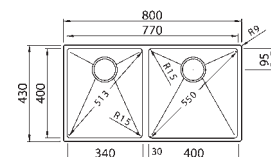

90mm Deco Strainer Waste included with all Stereo sinks



Plumbing Kit included with multi-bowl sinks



Deluxe Strainer Waste (upgrade) Chrome £20 Brushed £32

Undermount Cutouts
DXF drawings are available for download.



Icons Explained
see page 72-73



Ref. RM2000 Stainless Steel Draining Mat (round bar) £59
Ref. DR3000 Stainless Steel Draining Mat (square bar) £59



STARK UNDERMOUNT



The **Stark** are a range of luxury sinks that have taken minimalism to new heights with their pure rectilinear lines. Durability is assured with 1.0mm gauge stainless steel coated with **SilentCote®** sound-proofing thermal paint on the underside (see page 73).

Optional Accessories



Ref. COL103 Stainless Steel Colander £120



Ref. COL105 Stainless Steel Colander £83



Stark 1.5 bowl shown with Zuben Stainless Steel Filter tap - see page 159

SINKS STAINLESS STEEL UNDERMOUNT

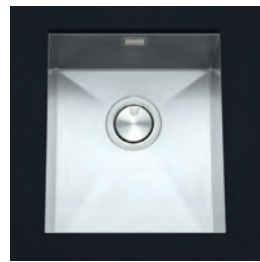

Stark Single bowl
Ref. SK34 £315
Overall size: 380/440 mm
Bowl size: 340/400/200 mm
Minimum cabinet size: 400 mm

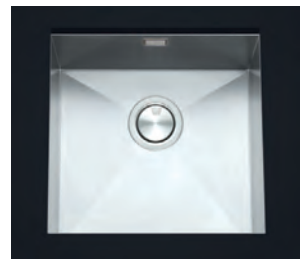
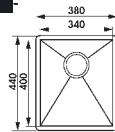

Stark Single bowl
Ref. SK40 £360
Overall size: 430/430 mm
Bowl size: 400/400/200 mm
Minimum cabinet size: 450 mm

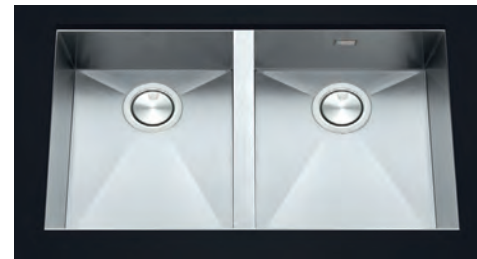
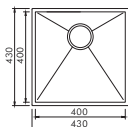

Stark Double bowl
Ref. SK77 £776
Overall size: 430/800 mm
Left bowl: 340/400/200 mm
Right bowl: 400/400/200 mm
Minimum cabinet size: 1000 mm

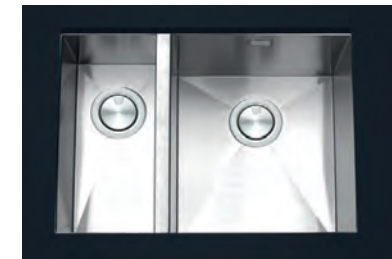
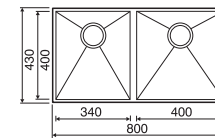

Stark 1.5 bowl
Ref. SK55 £500
Overall size: 580/430 mm
Main bowl: 340/400/200 mm
Half bowl: 180/400/140 mm
Min cabinet size: 600 mm

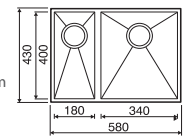

Stark Single bowl
Ref. SK45 £380
Overall size: 490/440 mm
Bowl size: 450/400/200 mm
Minimum cabinet size: 500 mm

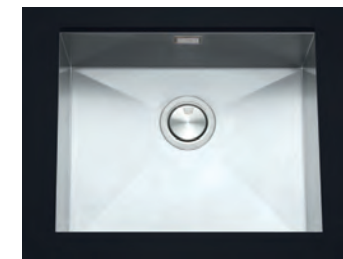
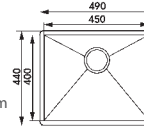

Stark Single bowl
Ref. SK50 £400
Overall size: 540/440 mm
Bowl size: 500/400/200 mm
Minimum cabinet size: 600 mm

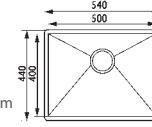

90mm Deco Strainer Waste included with all Stereo sinks



Plumbing Kit included with multi-bowl sinks



Deluxe Strainer Waste (upgrade) Chrome £20 Brushed £32

Undermount Cutouts
DXF drawings are available for download.



Icons Explained see page 72-73



Stark Smart SKS006 shown as inset with Juno tap in Chrome - see page 172



Stark Smart SKS005 shown as undermount with Jovian tap in White - see page 179

ACCESSORIES Included



Ref. WBD426
Wooden Chopping Board

ACCESSORIES Optional



Ref. DB05
Stainless Steel Tray £46



Ref. COL105
Stainless Steel Colander £83



90mm Deco
Strainer Wastes
included with
all Stark sinks



Deluxe Strainer
Waste (upgrade)
Chrome £20
Brushed £32

**Undermount
Cutouts**
DXF drawings
are available
for download.



Stark Smart Single bowl
Ref. SKS001 £419

Overall size: 440/490 mm
Bowl size: 380/400/220 mm
Cutout size: 420/470 mm (Inset)
Minimum cabinet size: 500 mm
Waste included: 90 mm BSW

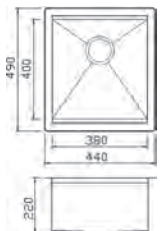

Stark Smart Single bowl
Ref. SKS002 £449

Overall size: 540/490 mm
Bowl size: 480/400/220 mm
Cutout size: 520/470 mm (Inset)
Minimum cabinet size: 600 mm
Waste included: 90 mm BSW

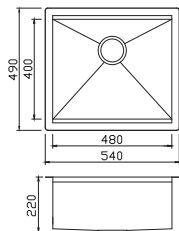

Stark Smart Single bowl
Ref. SKS003 £509

Overall size: 660/490 mm
Bowl size: 600/400/220 mm
Cutout size: 640/470 mm (Inset)
Minimum cabinet size: 700 mm
Waste included: 90 mm BSW

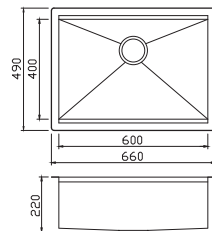

Stark Smart Single bowl
Ref. SKS004 £639

Overall size: 800/490 mm
Bowl size: 740/400/220 mm
Cutout size: 780/470 mm (Inset)
Minimum cabinet size: 1000 mm
Waste included: 90 mm BSW

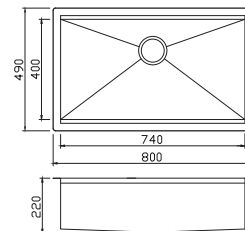

Stark Smart 1.5 bowl
Ref. SKS005 £519

Overall size: 600/490 mm
Bowl size: 360/400/220 mm
Half Bowl: 150/400/220 mm
Cutout size: 580/470 mm (Inset)
Minimum cabinet size: 700 mm
Wastes included: 2 x 90 mm BSW & Plumbing Kit

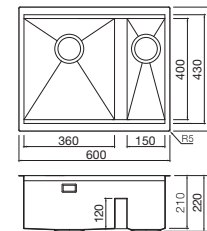

Stark Smart 1.5 bowl
Ref. SKS006 £649

Overall size: 740/490 mm
Bowl size: 500/400/220 mm
Half Bowl: 150/400/220 mm
Cutout size: 720/470 mm (Inset)
Minimum cabinet size: 800 mm
Wastes included: 2 x 90 mm BSW & Plumbing Kit

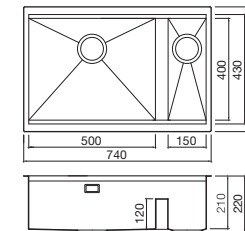

STARK SMART UNDERMOUNT/INSET



The **Stark Smart** sinks have an ultra-contemporary style with zero radius bowls. They have been designed with the cook in mind with built-in accessory ledges which house custom-fit accessories. These include a wooden chopping board which is supplied with each sink and an optional strainer colander and strainer tray. These sit snugly on their ledges freeing up both hands for tasks such as rinsing vegetables and straining pasta.

The Smart accessories have transformed the Stark from a humble sink into a clever workstation.



Volta VL650S shown as undermount with Pioneer Pull-out tap in Brushed Nickel - see page 192



Volta Single bowl
Ref. VL185 £235
Overall size: 220/440 mm
Bowl size: 180/400/190 mm
Cutout size: 200/420 mm (Inset)
Minimum cabinet size: 300 mm
Waste included: 90 mm BSW

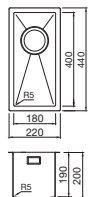

Volta Single bowl
Ref. VL400S £300
Overall size: 440/440 mm
Bowl size: 400/400/190 mm
Cutout size: 520/420 mm (Inset)
Minimum cabinet size: 500 mm
Waste included: 90 mm BSW

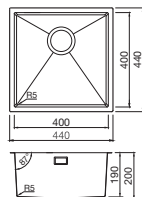

Volta Single bowl
Ref. VL500S £335
Overall size: 540/440 mm
Bowl size: 500/400/190 mm
Cutout size: 520/420 mm (Inset)
Minimum cabinet size: 600 mm
Waste included: 90 mm BSW

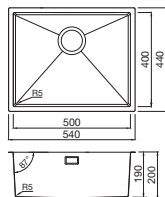

Volta Single bowl
Ref. VL650S £390
Overall size: 690/440 mm
Bowl size: 650/400/190 mm
Cutout size: 670/420 mm (Inset)
Minimum cabinet size: 800 mm
Waste included: 90 mm BSW

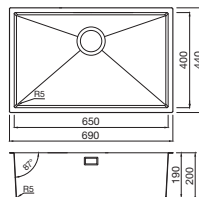

Volta VL53LS shown as undermount with Karuma Pull-out tap in Brushed Nickel - see page 190



Volta 1.5 bowl
Ref. VL53LS LH Main Bowl £535
Ref. VL53RS RH Main Bowl £535
Overall size: 575/450 mm
Bowl size: 340/400/190 mm
Half bowl: 180/400/190 mm
Cutout size: 555/430 mm (Inset)
Minimum cabinet size: 600 mm
Wastes included: 2 x 90 mm BSW & Plumbing Kit

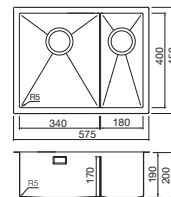

Volta 1.5 bowl
Ref. VL68LS LH Main Bowl £605
Ref. VL68RS RH Main Bowl £605
Overall size: 735/450 mm
Bowl size: 500/400/190 mm
Half bowl: 180/400/190 mm
Cutout size: 715/430 mm (Inset)
Minimum cabinet size: 800 mm
Wastes included: 2 x 90 mm BSW & Plumbing Kit

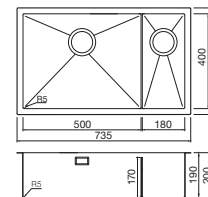

VOLTA UNDERMOUNT/INSET



The **Volta** has fine radius corners and smart draining lines creating a very modern statement. There are six options to choose from, including two versatile 1.5 bowl models which feature a unique slim bowl divider reinforcing the Volta's sophisticated design.

The Volta is manufactured in 1.0 thick steel which has been treated with **SilentCote®** to enhance its robust qualities and provide hushed tones when in use.

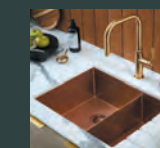

See the PVD Voltas on pages 116-117



90mm Deco Strainer Wastes included with all sinks

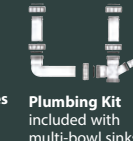

Plumbing Kit included with multi-bowl sinks



Deluxe Strainer Waste (upgrade)
Chrome £20
Brushed £32

Undermount Cutouts
DXF drawings are available for download



Volta VL650DBB shown as undermount with Rococo Twist & Spray tap in Artisan Brass - see page 168



Volta VL53LDBC shown as undermount with Pioneer Pull-out tap in Brushed Brass - see page 192

Dura Finish

A unique random brushed effect providing a rich patina that disguises scratches. This prolongs its original looks beyond other finishes.

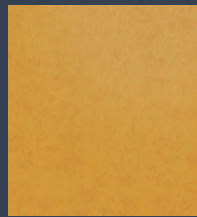

Brass

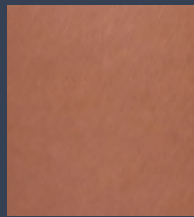

Copper

Volta PVD Properties

- Higher resistance to scratches and abrasions.
- Higher corrosion resistance.
- High resistance to domestic chemicals and cleaners.
- Hygienic surface – suitable for food contact.
- Enhanced decorative finish.



Volta Single bowl
Ref. VL400DBB £435
Overall size: 440/440 mm
Bowl size: 400/400/190 mm
Cutout size: 420/420 mm (Inset)
Minimum cabinet size: 500 mm
Waste included: 90 mm BSW

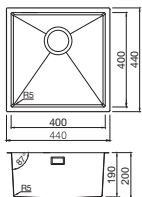

Volta Single bowl
Ref. VL500DBB £485
Overall size: 540/440 mm
Bowl size: 500/400/190 mm
Cutout size: 520/420 mm (Inset)
Minimum cabinet size: 600 mm
Waste included: 90 mm BSW

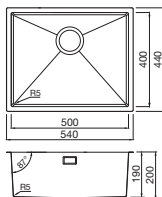

Volta Single bowl
Ref. VL650DBB £540
Overall size: 690/440 mm
Bowl size: 650/400/190 mm
Cutout size: 670/420 mm (Inset)
Minimum cabinet size: 800 mm
Waste included: 90 mm BSW

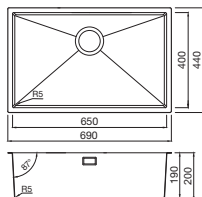

Volta 1.5 bowl
Ref. VL53LDBC LH Main Bowl £655
Ref. VL53RDBC RH Main Bowl £655
Overall size: 575/450 mm
Bowl size: 340/400/190 mm
Half bowl: 180/400/190 mm
Cutout size: 555/430 mm (Inset)
Minimum cabinet size: 600 mm
Wastes included: 2 x 90 mm BSW & Plumbing Kit

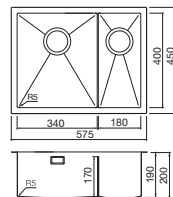

Volta Single bowl
Ref. VL500DBC £485
Overall size: 540/440 mm
Bowl size: 500/400/190 mm
Cutout size: 520/420 mm (Inset)
Minimum cabinet size: 600 mm
Waste included: 90 mm BSW

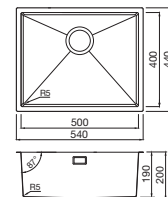

Volta 1.5 bowl
Ref. VL53LDBC £655
Ref. VL53RDBC £655
Overall size: 575/450 mm
Bowl size: 340/400/190 mm
Half bowl: 180/400/190 mm
Cutout size: 555/430 mm (Inset)
Minimum cabinet size: 600 mm
Wastes included: 2 x 90 mm BSW & Plumbing Kit

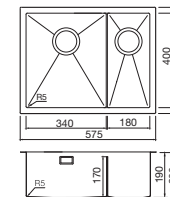

VOLTA PVD UNDERMOUNT/INSET



The **Volta PVD** range is our latest elegant range of bowls that can be fitted in both under-mount and inset applications. The bowls have crisp 5mm radius corners and stylish pressed draining-lines. They are all available in Brass, Bronze and a very chic Black finish (see over page). These special finishes are created using a PVD process that provides an extremely resilient surface. The Dura-Brushed finish is a unique random brushed effect, providing a rich patina that disguises scratches and prolongs its original looks.

The Volta 1.5 model features a slick, ultra-slim bowl divider that maximises the bowls capacity whilst retaining an overall compact dimension, ensuring that it fits into 60cm wide cabinetry.

All models have been constructed in 1.0 mm stainless steel and coated with **SilentCote®** on the underside for increased sound-proofing.



Undermount Cutouts
DXF drawings are available for download



Icons Explained
see page 72-73



Volta VL53LBL shown as undermount with Morpho Matt Black tap with flex and stay spout - see page 176-177



Volta VL650BL shown as undermount with Tutti Twist & Spray tap in Matt Black - see page 169

VOLTA PVD UNDERMOUNT/INSET



The **Volta PVD Black** is black - not compromised tones of dark grey that is usually on offer. This pure colour creates a very sophisticated presence in the kitchen and is certainly statement making. The PVD properties add a very resistant surface and the Volta Black has also been treated with Nano technology. This has created a uniquely smooth surface which is not only dirt repellent but is extremely hygienic.

These sleek sinks are fabricated in 1.0 steel and have been treated with **SilentCote®** to increase the robustness and add hushed tones when in use.

The 1.5 bowl model has a very slim bowl divider adding a very contemporary aesthetic whilst maximising the bowl dimensions.



Volta 1.5 bowl
Ref. VL53LBL £700
 Overall size: 575/450 mm
 Bowl size: 340/400/190 mm
 Half bowl: 180/400/190 mm
 Cutout size: 555/430 mm (Inset)
 Minimum cabinet size: 600 mm
 Wastes included: 2 x 90 mm BSW & Plumbing Kit

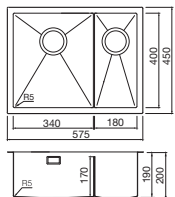

Volta 1.5 bowl
Ref. VL53RBL £700
 Overall size: 575/450 mm
 Bowl size: 340/400/190 mm
 Half bowl: 180/400/190 mm
 Cutout size: 555/430 mm (Inset)
 Minimum cabinet size: 600 mm
 Wastes included: 2 x 90 mm BSW & Plumbing Kit

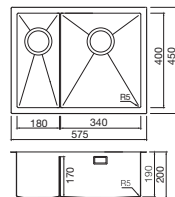

NANO COATING

Nano Coating is the process of applying an ultra-thin surface layer which gives the product a mechanically flat surface. Which repels dry particles, water, oil, and dirt. Resulting in a product that is dirt repellent and more hygienic, easier to clean and more resistant to scratches and chemicals. Other benefits include a reduction in grease and finger marks.



Properties

- Dirt Repellent and Hygienic
- Hydrophobic
- Chemical Resistance
- Ultraviolet Resistance
- Reduces Grease and Finger Marks



Volta Single bowl
Ref. VL400BL £450

Overall size: 440/440 mm
 Bowl size: 400/400/190 mm
 Cutout size: 420/420 mm (Inset)
 Minimum cabinet size: 500 mm
 Waste included: 90 mm BSW

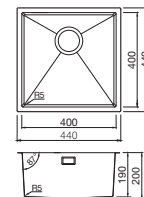

Volta Single bowl
Ref. VL500BL £490

Overall size: 540/440 mm
 Bowl size: 500/400/190 mm
 Cutout size: 520/420 mm (Inset)
 Minimum cabinet size: 600 mm
 Waste included: 90 mm BSW

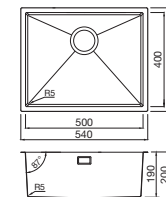

Volta Single bowl
Ref. VL650BL £550

Overall size: 690/440 mm
 Bowl size: 650/400/190 mm
 Cutout size: 670/420 mm (Inset)
 Minimum cabinet size: 800 mm
 Waste included: 90 mm BSW

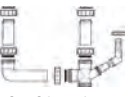
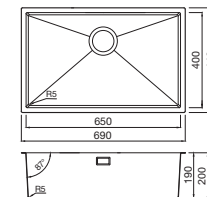

Plumbing Kit
 included with multi-bowl sinks

Undermount Cutouts
 DXF drawings are available for download.



Icons Explained
 see page 72-73



Salsa SA45BB shown as undermount with Loreto tap in Brushed Brass - see page 176



Salsa SA55LRC shown as undermount with Rococo Twist & Spray tap in Regency Copper - see page 168

Satin Finish

A very fine brushed swirled effect.

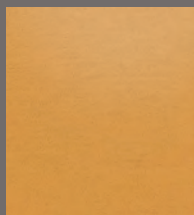

Brass

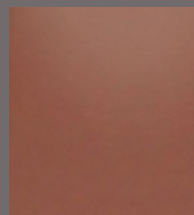

Copper

Salsa PVD Properties

- Higher resistance to scratches and abrasions.
- Higher corrosion resistance.
- High resistance to domestic chemicals and cleaners.
- Hygienic surface – suitable for food contact.
- Enhanced decorative finish.

SALSA PVD UNDERMOUNT/INSET



The **PVD Salsa** undermount/inset bowl collection are our most economical range of PVD sinks. Choose from two single bowl size options or a versatile 1.5 model. The Brass or Copper colour choices add a warm glamorous effect and the durable PVD qualities provide a higher level of scratch and abrasion resistance. The **SilentCote®** sound proofing compound has also been applied to the underside for added hushed tones.



Plumbing Kit included with multi-bowl sinks

Undermount Cutouts DXF drawings are available for download



Salsa Single bowl Ref. SA35BB £335

Overall size: 390/440 mm
Bowl size: 350/400/195 mm
Minimum cabinet size: 400 mm
Wastes included: 90 mm BSW

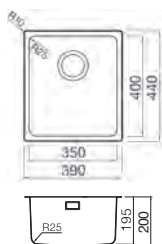

Salsa Single bowl Ref. SA45BB £400

Overall size: 490/440 mm
Bowl size: 450/400/195 mm
Minimum cabinet size: 500 mm
Wastes included: 90 mm BSW

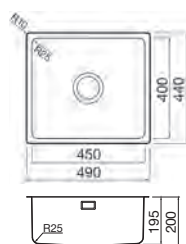

Salsa 1.5 bowl (Undermount only) Ref. SA55LBB £520

Overall size: 600/440 mm
Bowl size: 350/400/195 mm
Half bowl: 180/300/98 mm
Minimum cabinet size: 600 mm
Wastes included: 2 x 90 mm BSW & Plumbing Kit

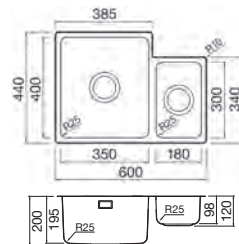

Salsa 1.5 bowl (Undermount only) Ref. SA55LRC £520

Overall size: 600/440 mm
Bowl size: 350/400/195 mm
Half bowl: 180/300/98 mm
Minimum cabinet size: 600 mm
Wastes included: 2 x 90 mm BSW & Plumbing Kit

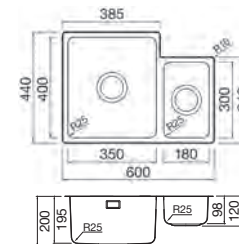

Salsa Single bowl Ref. SA45RC £400

Overall size: 490/440 mm
Bowl size: 450/400/195 mm
Minimum cabinet size: 500 mm
Wastes included: 90 mm BSW

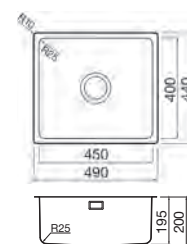

Salsa Single bowl Ref. SA35RC £335

Overall size: 390/440 mm
Bowl size: 350/400/195 mm
Minimum cabinet size: 400 mm
Wastes included: 90 mm BSW

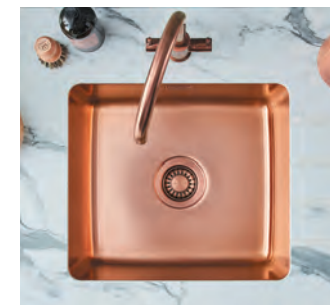
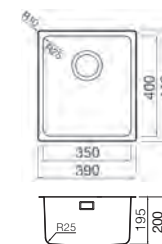

APRON FRONTED

Our stainless steel Apron Fronted range consists of the ever popular **Belfast** shown on this page and the fabulous double bowl **Infinity Smart** which uses an integrated ledge to incorporate a range of useful accessories.



In this installation the sink is fitted directly onto a cabinet with its front fascia exposed. This type of installation is only suitable for solid surface worktops such as Granite, Marble or Wood.



Belfast shown with Titania T12SS Stainless Steel tap - see page 202



Belfast shown with Rosetta Filter tap in Brushed Nickel - see page 146

SINKS STAINLESS STEEL BUTLER



Belfast Single bowl
Ref. INR001 £563
 Overall size: 600/465 mm
 Bowl size: 530/395/229 mm
 Waste included: 90 mm BSW

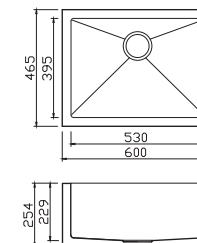

BELFAST



This fabulous incarnation of the traditional ceramic Butler sink transports an old classic to the 21st century with great style.

The **Belfast** has lost none of the capacious dimensions of its ceramic cousin and is an ideal choice for the cook's kitchen as it can take on the largest pans and trays with ease.



ACCESSORIES Included



Ref. WBD426
Wooden Chopping Board



Ref. DB05
Stainless Steel Tray

ACCESSORIES Optional



Ref. DB03
Stainless Steel Plate Rack £40
(fits within the DB05 Tray)



Ref. COL105
Stainless Steel Colander £83

Infinity Smart INS002 shown with sliding chopping board



Infinity Smart INS002 shown with Magus 3 Kettle tap in Brushed Nickel - see page 134-135

SINKS STAINLESS STEEL BUTLER



Infinity Smart Single bowl
Ref. INS001 £668
Overall size: 600/510 mm
Bowl size: 530/400/229 mm
Waste included: 90 mm BSW

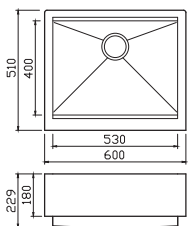

Infinity Smart Single bowl
Ref. INS002 £750
Overall size: 800/510 mm
Bowl size: 730/400/229 mm
Waste included: 90 mm BSW

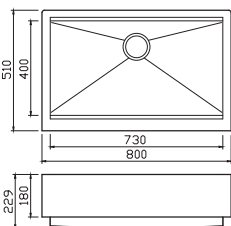

Infinity Smart 1.5 bowl
Ref. INS003 £863
Overall size: 800/510 mm
Bowl size: 426/400/229 mm
Half bowl: 264/400/229 mm
Waste included: 2 x 90 mm BSW & Plumbing Kit

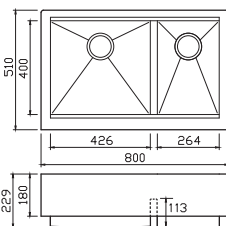

Infinity INS003 showing the low partition flood wall

INFINITY SMART



The **Infinity Smart** Butler sinks create a lustrous focal point in the kitchen, the architectural aesthetics are enhanced by the slender front apron which disguises the true depth of these sinks adding to their sophisticated appearance.

All models have a unique integrated ledge to accommodate an essential range of accessories that maximize the Infinity Smart's abilities. Please note the 1.5 bowl model has low partition wall which allows both bowls to be flooded to create a larger washing area.

90 mm Strainer Wastes

WASTE ONLY

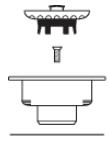

Stainless Steel
Ref. W90C £24



Brushed Steel
with hinged cover
Ref. W90SC £24



Matt Black
Ref. W90MB £53

PVD COATED



Gold
Ref. W90G £53



Artisan Brass
Ref. W90AB £53



Regency Copper
Ref. W90RC £53

WASTE WITH OVERFLOW



Stainless Steel
Ref. W90OC £30



Brushed Steel
with hinged cover
Ref. W90OSC £30



Matt Black
Ref. W90OMB £69

PVD COATED



Gold
Ref. W90OG £69



Artisan Brass
Ref. W90OAB £69



Regency Copper
Ref. W90ORC £69

PVD coated wastes can only be supplied with B or C overflows.



60 mm Strainer Wastes

70mm FLANGE



Stainless Steel
Ref. W60C £27



Brushed Steel
Ref. W60BS £37



Matt Black
Ref. W60MB £37



Artisan Brass
Ref. W60AB £43



Regency Copper
Ref. W60RC £43

PVD COATED

85mm FLANGE



Stainless Steel
Ref. WRPC £30

PVD COATED



Gold
Ref. WRPG £47



Artisan Brass
Ref. WRPAB £47



Regency Copper
Ref. WRPRC £47

90 mm Deluxe Strainer Wastes



Chrome
Ref. DWC £37
Brushed Steel
Ref. DWB £40

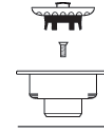

Chrome
Ref. DWOC £39
Brushed Steel
Ref. DWOB £42



Thomas Denby Waste Kits

Prices apply to wastes with or without overflows
Please state type required



Single Bowl Kit
TD1WC
Chrome £61
Double Bowl Kit
TD2WC
Chrome £113



Single Bowl Kit
TD1WBS
Brushed Steel £68
Double Bowl Kit
TD2WBS
Brushed Steel £129



Single Bowl Kit
TD1WBB
Brushed Brass £106
Double Bowl Kit
TD2WBB
Brushed Brass £190



Single Bowl Kit
TD1WRC
Regency Copper £106
Double Bowl Kit
TD2WRC
Regency Copper £190



Single Bowl Kit
TD1WBR
Bronze £106
Double Bowl Kit
TD2WBR
Bronze £190



Single Bowl Kit
TD1WNI
Polished Nickel £106
Double Bowl Kit
TD2WNI
Polished Nickel £190

OVERFLOWS

Add A, B, C, D or E as suffix to waste code

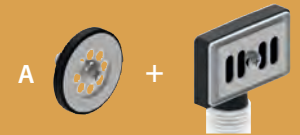

Type A includes both round and rectangular plate

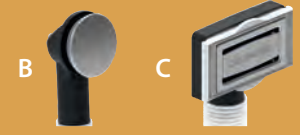

Round Plate Rectangular Plate

Thomas Denby



Round Plate Rectangular Plate

PRESTO Automatic Wastes

The **Presto** uses the latest technology for waste control; it only takes a light press of the control button to open and close the waste - no more struggling to twist a control switch with wet hands.

Presto Pop-Up Waste Ref. WP10

Chrome £44
Brushed Steel £44
Artisan Brass £114
Regency Copper £114
Matt Black £75



Contract Wastes



1.5" Waste & Overflow
Ref. WCWO Chrome: £7



1.5" Belfast Slotted Waste (weir overflow)
Ref. WBESC Chrome: £33

Plumbing Kits

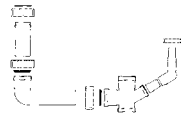

Plumbing Kit for 1.5 bowl
Ref. WPK15 £17



Plumbing Kit for 2 bowl
Ref. DMPK2 £17



Sink Waste Trap
Ref. WST £22

Space Saver Plumbing Kits

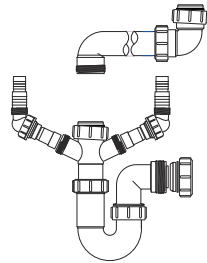

Space Saver Plumbing Kit for single bowl
Ref. SSK1 £27

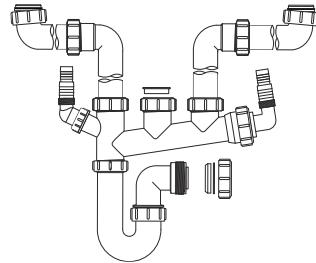

Space Saver Plumbing Kit for 1.5 and double bowl
Ref. SSK2 £47

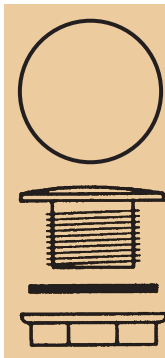

Tap Hole Covers

Ref. THP
Polished: £3

Ref. THL
Linen: £3

Ref. THB
Brushed: £3

Ref. ASP2058
Ceramic: £7

LINEA

Waste Sorter Bins

Now waste recycling has become mandatory a waste bin system that offers versatility whilst fitting neatly in to standard kitchen units is here in the shape of the Linea. There are 4 models to choose from with single and multi material bins in various sizes so there should be the right one for most peoples lifestyles.

Ref. 2A1100 Linea 130 £116

Material: Casing ABS - Bins polypropylene
Minimum cabinet size: 300mm
Minimal Installation dimension: H 433mm W 253mm D 467mm
Bin size: 1 x 30 litre
Operation: Manual - front pull-out
With runners & ball bearings
Fixed lid
Warranty: 2 years
Conforms to the code for sustainable homes - 4 credits

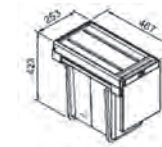

Ref. 2A1101 Linea 330 £116

Material: Casing ABS - Bins polypropylene
Minimum cabinet size: 300mm
Minimal Installation dimension: H 433mm W 253mm D 467mm
Bin size: 3 x 10 litre
Operation: Manual - front pull-out
With runners & ball bearings
Fixed lid
Warranty: 2 years
Conforms to the code for sustainable homes - 4 credits

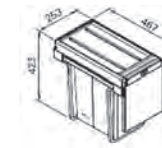

Ref. 2A1103 Linea 332 £155

Suitable to fit under a sink bowl
Material: Casing ABS - Bins polypropylene
Minimum cabinet size: 500mm
Minimal Installation dimension: H 340mm W 438mm D 330mm
Bin size: 1 x 16 litre, 2 x 8 litre
Operation: Manual - front pull-out
With runners & ball bearings
Fixed lid
Warranty: 2 years
Conforms to the code for sustainable homes - 4 credits

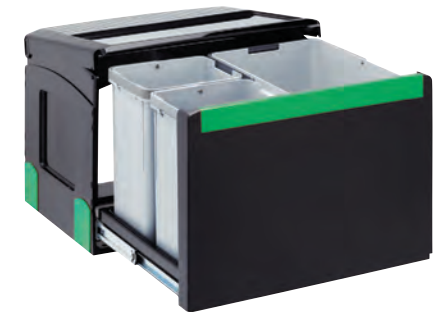
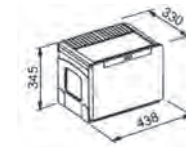

Ref. 2A1102 Linea 360 £241

Material: Casing ABS - Bins polypropylene
Minimum cabinet size: 600mm
Minimal Installation dimension: H 433mm W 510mm D 467mm
Bin size: 1 x 30 litre, 2 x 15 litre
Operation: Manual - front pull-out
With runners & ball bearings
Fixed lid
Warranty: 2 years
Conforms to the code for sustainable homes - 2 credits

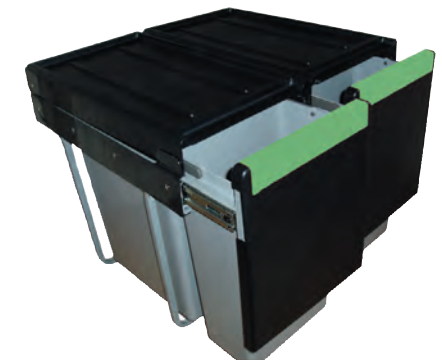
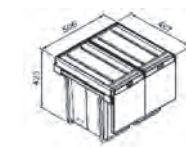

Replacement Filter Cartridges



Pure Filter Tap Filter
Ref. P6C1 £55

Each filter delivers 3800 litres of filtered water at a fraction of the price of bottled water.

Filtered water untainted by the taste of heavy metals, limescale and chlorine results in fresh, great tasting water straight from the tap.

WRAS Approved



Magus, Hotshot & Nexus Kettle Filter (6 month)
Ref. F6C1 £72

This filter has a 6 month life span and a capacity of 3800 litres.

Filtered water is untainted by the taste of heavy metals, limescale and chlorine.

NSF REG4 Approved



Magus, Hotshot & Nexus Kettle Filter (12 month)
Ref. F12C1 £112

This filter has a 12 month life span and a capacity of 7600 litres.

Filtered water is untainted by the taste of heavy metals, limescale and chlorine.

WRAS Approved



TAPS CHOICES

FINISHES

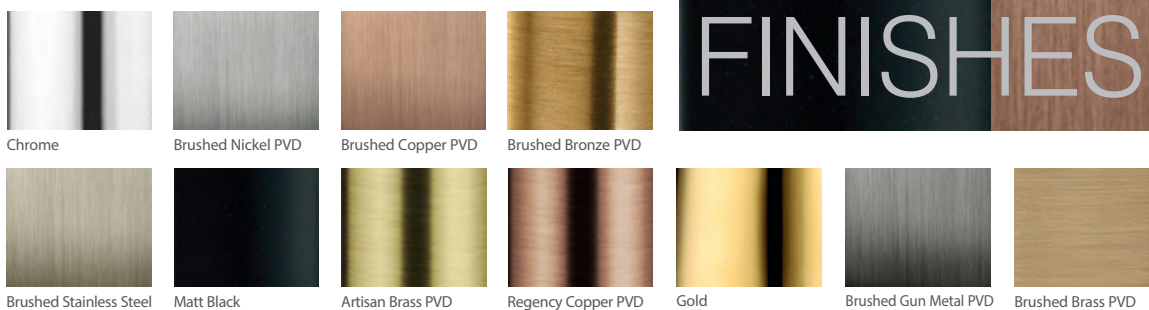

WATER PRESSURE - IDENTIFY YOUR SYSTEM

To be sure you get the best performance from your tap you need to identify the plumbing system in your home to be able to determine the water pressure there.

Use the following information as a guide to help you to do this, it is recommended that you get the opinion of a professional tradesman who can check the pressure with a pressure gauge.

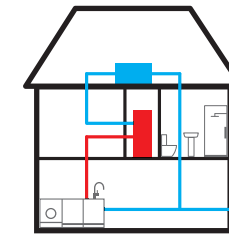

Gravity Fed (Low pressure) Systems

- Cold water storage tank in loft
 - Hot water cylinder in airing cupboard
 - Hot water pressure is calculated by measuring the height from the storage tank to the tap
- Example
 1M drop = 0.1 bar pressure
 2M drop = 0.2 bar pressure
 5M drop = 0.5 bar pressure

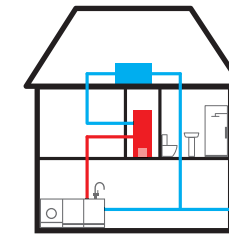

Boosted Gravity Fed Systems

- Cold water storage tank in loft
 - Hot water cylinder in airing cupboard
 - Hot water pressure is determined by a separately fitted pump (refer to manufacturers specifications)
- Usual pressure 1-3 bar

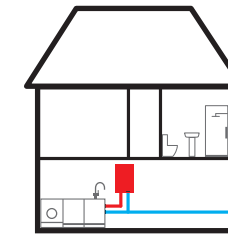

Combination Boiler Systems

- A combi boiler delivering hot and cold water on demand
 - No storage tanks
 - No shower pump
 - Hot water pressure is dictated by the mains pressure and power of the boiler
- Usual pressure between 1 and 1.5 bar

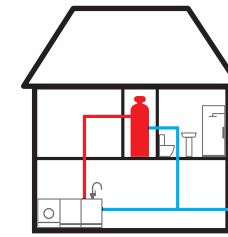

Mains High Pressure Systems

- Unvented cylinder with expansion vessel (eg 'Megaflo')
 - No cold storage tanks
 - No shower pump
 - Hot water pressure is dictated by mains pressure
- Usual pressure between 2 and 3 bar

All taps are shown with a minimum operating pressure symbol as below. Use this symbol to select the correct tap for your water system; for example if you have a gravity fed system with a 5 metre drop you will have 0.5 bar pressure and you should choose a minimum 0.5 bar tap or lower. If you have a high pressure system for example 3 bar you can choose any of our taps.

TAP ICONS - EXPLAINED

Throughout the following Tap Sections you will see these icons next to products where relevant.



The Cascade SLC aerator offers anti-limescale features, with a rubber face to prevent scale amalgamation, simple to clean with just a gentle rub.



Cold Start Energy saving cartridge means when the lever is in the vertical position, it only dispenses cold water and not mixed. Forward rotation avoids the lever hitting the splashback.



Pull-out Aerated Spray Increases operating range of the tap supplying a single aerated flow.



Pull-out Dual Flow Spray Increases operating range of the tap and provides easy switching from aerated flow to needle spray.



Dual Flow Keeps the flow of hot and cold water separate in the tap Spout.



Minimum Operating Pressure



Maximum Spout Swivel



Professional Dual Flow Spray 360° flexible spout with easy switching from aerated flow to needle spray.



Professional Single Flow 360° flexible spout with single aerated flow.



Twist & Spray A simple twist of the spout flange will change the water from aerated to needle jet flow.



WARRANTY

We offer a 5 year warranty from date of purchase on all working parts and valves for our taps, decorative surfaces are guaranteed for 1 year from purchase date providing care instructions have been followed and in particular no scouring agents have been used.



PACKAGING

All our taps are supplied in robust boxes with protective foam individually protecting the tap and its separate parts, thus ensuring your tap arrives complete and in perfect condition.

KETTLE TAPS kettle®



FILTERED KETTLE HOT WATER ON TAP

Once you have one, you'll wonder how you ever lived without it.

OPTIONS

SINGLE FUNCTION

Filtered 98°C water

DUAL FUNCTION

Filtered 98°C water

Filtered cold water

TRIPLE FUNCTION

Domestic hot water

Domestic cold water

Filtered 98°C water

QUADRUPLE FUNCTION

Domestic hot water

Domestic cold water

Filtered 98°C water

Filtered cold water

KETTLE TAP

SPEED

No more waiting for the kettle to boil - 98° hot filtered water is always instantly available. It takes up to 5 minutes to boil a litre of water using an electric kettle, it takes zero minutes using a Kettle tap.

TASTE

The water before entering the boiler is filtered to remove impurities, resulting in fresh odourless 98° hot water for superior tasting drinks.

WATER SAVING

You only dispense the precise amount of hot water you need, so you save on water and energy consumption. All our Kettle Tanks have a built in filter alert that lets you know when the filter needs replacing.

SAFETY

All our Kettle taps come with insulated spout technology and child-safe controls.

CLEAR THE DECKS

Declutter your work surfaces by ditching your kettle, all your boiling water requirements are fulfilled with a Kettle tap.

BENEFITS



Temperature Control

Ten precise temperature settings between 45°C and 98°C



F6C1 Filter

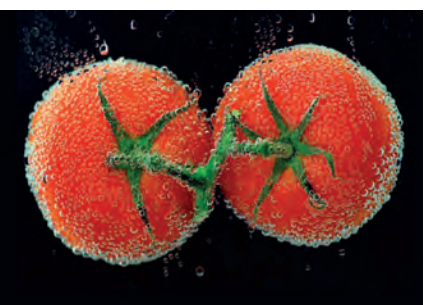
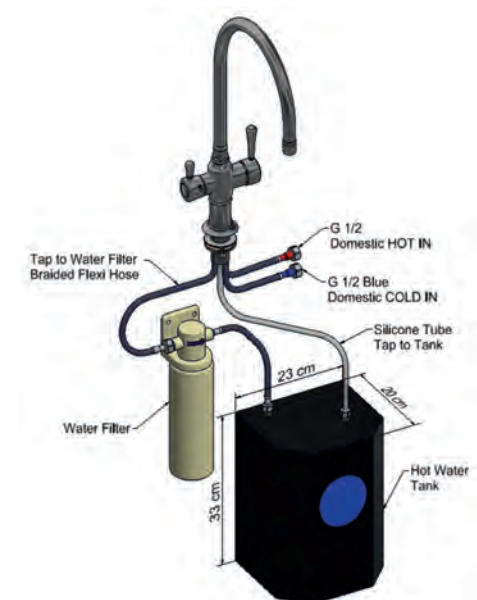
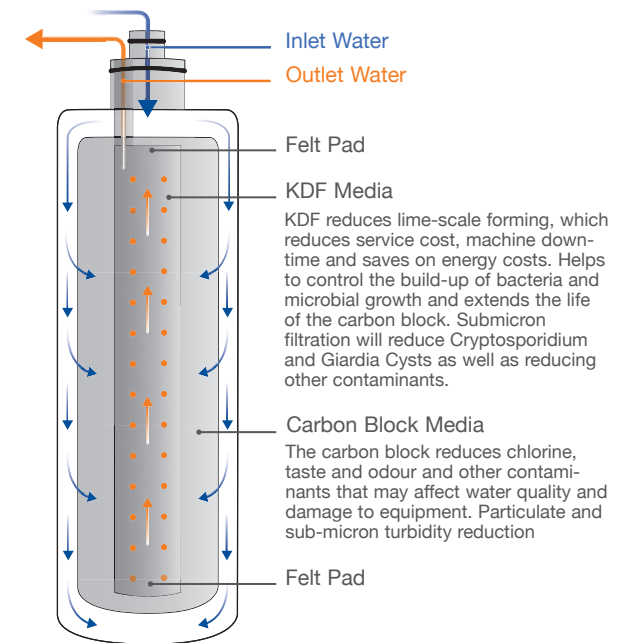

TAPS KETTLE INTRODUCTION

MAGUS 3

The Clearwater **Magus 3** IN 1 Kettle tap combines great aesthetics with outstanding functionality making it an indispensable time-saving appliance in the kitchen. Its versatility means it dispenses domestic hot and cold water as well as 98°C steaming hot, filtered water.

This brilliant kitchen assistant means no more waiting for the kettle to boil and instead you have immediate kettle hot perfectly tasting water for beverages and cooking.

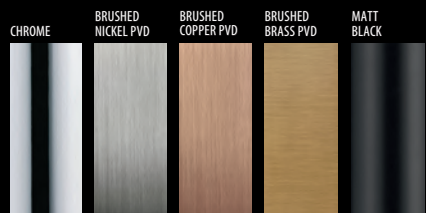

Chrome



Brushed Nickel PVD



Magus 3

Ref. MAE2KCP Chrome £714

Ref. MAE2KBN Brushed Nickel PVD £749

Ref. MAE2KBC Brushed Copper PVD £771

Ref. MAE2KBB Brushed Brass PVD £771

Ref. MAE2KMB Matt Black PVD £771

Included: Thermostatic Boiler, Filter Cartridge and Connectors
WRAS Approved

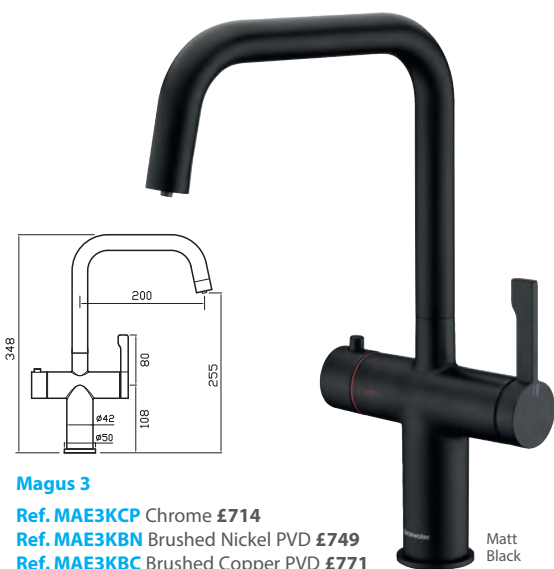

Magus 3

Ref. MAE3KCP Chrome £714

Ref. MAE3KBN Brushed Nickel PVD £749

Ref. MAE3KBC Brushed Copper PVD £771

Ref. MAE3KBB Brushed Brass PVD £771

Ref. MAE3KMB Matt Black £771

Included: Thermostatic Boiler, Filter Cartridge and Connectors
WRAS Approved



DIGITAL THERMOSTATIC BOILER

- **2.4 Litre capacity** - instant kettle hot water, capable of providing 60 cups per hour.
- **Simple installation** - non-specialist fitting uses standard 13 amp plug.
- **Anti-scale filter provided** - reduces lime-scale and improves water quality.
- **State-of-the-art Digital controls** - accurate to 0.5 degrees variable.
- **10 temperature settings** - from 45° to 98°.
- Operates from 1.5 bar.
- Ultra compact design.
- Automated Filter Reminder System.
- 2 year warranty.

Boiler Dimensions

Width 188 mm
Depth 188 mm
Height 270 mm



FUNCTIONS

- **3 Functions** - domestic hot, domestic cold, 98°C filtered water.
- **Child safe operation** - spring loaded lever dispenses 98°C filtered water.
- **Cool touch spout** - centrally insulated 98°C channel ensuring spout remains safe to touch.
- **Advanced filtration** - protects the boiler from lime-scale formation, removes contaminants and improves taste and odour of the water to achieve the perfect hot & cold drinks.

FILTER CARTRIDGE

The filter cartridge included has a 6 month life span and a capacity of 3800 litres.

Replacement Cartridges

Ref. F6C1 - £72 - WRAS Approved

An optional filter with a 12 month life span is also available with a capacity of 7600 litres.

Ref. F12C1 - £112 - WRAS Approved



MAGUS 4 ELECTRONIC kettle



Magus 4 with Modern Pull-Out Spray in Matt Black - see page 206

For chilled filtered water see our **Chiller** on page 159.

The **Magus 4 Electronic** really is the complete package; it combines elegant design with intuitive controls that deliver four water options. The left-hand LED electronic control dispenses 98°C filtered water at the touch of a button while the right-hand lever delivers domestic hot and cold water as well as fresh tasting cold filtered water. When you own a Magus 4 you will never need to use your kettle or buy bottled water again!

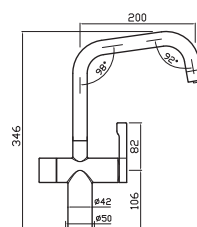

Magus 4 in 1

- Ref. MAE4CP** Chrome **£850**
- Ref. MAE4BN** Brushed Nickel PVD **£883**
- Ref. MAE4BC** Brushed Copper PVD **£907**
- Ref. MAE4BB** Brushed Brass PVD **£907**
- Ref. MAE4MB** Matt Black **£907**

Included: Thermostatic Boiler, Filter Cartridge and Connectors

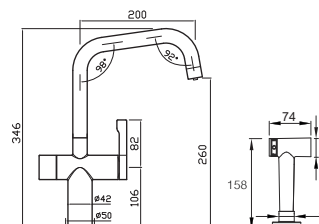

Magus 4 in 1 with Dual Pull-Out Spray

- Ref. MAER4CP** Chrome **£950**
- Ref. MAER4BN** Brushed Nickel PVD **£997**
- Ref. MAER4BB** Brushed Brass PVD **£1031**
- Ref. MAER4MB** Matt Black **£1026**

Included: Thermostatic Boiler, Filter Cartridge and Connectors



clearwater

kettle

Matt Black



pure

Brushed Nickel : Filtered Water

THERMOSTATIC BOILER

For specification and dimensions see Magus 3 Kettle tap on page 135.



FILTER CARTRIDGE

The filter cartridge included has a 6 month life span and a capacity of 3800 litres.

Replacement Cartridges
Ref. F6C1 £72 - WRAS Approved

An optional filter with a 12 month life span is also available with a capacity of 7600 litres.

Ref. F12C1 £112 - WRAS Approved



- **4 Functions** - domestic hot, domestic cold, 98°C filtered water and cold filtered water.
- **Press & Hold or Hands-Free Kettle operation** - the Magus 4 is programmed to dispense water by pressing and holding control or simply press twice for hands-free mode.
- **Child safe operation** - advanced electronic control with LED illumination denoting hot function.
- **Cool touch spout** - centrally insulated 98°C channel ensuring spout remains safe to touch.
- **Advanced filtration** - protects the boiler from limescale formation, removes contaminants and improves taste and odour of the water to achieve the perfect hot and cold drinks.

KETTLE CONTROL



1 LED glows Blue - indicates the child lock is on.

2 Press control for 3 seconds to unlock - LED glows red and flickers.

3 Press control again and hold to dispense 98°C water - LED glows constant red.

4 Release pressure on control to cease flow - LED glows blue after 10 seconds, child lock on.

5 Hands-free control - Press control twice to dispense 98° filtered water - auto switch off after 60 seconds (approx 2 litres). To stop continuous flow press control again.



HOTSHOT ^{kettle}

The **Hotshot 1** is a compact filtered hot water tap which can be set alongside your main tap or installed with a secondary sink creating a fantastic entertaining area.

The Hotshot 1 can also be fitted with a font extending its application away from the kitchen, for example try fitting in the home office for that instant coffee fix.

The **Hotshot 2** brings even more to the party by not only dispensing 98°C super-hot water but also great tasting, cold filtered water, making this little tap the perfect choice for entertaining.

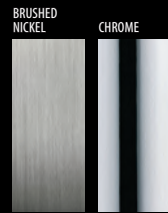

THERMOSTATIC BOILER



For specification and dimensions see **Magus 3 Kettle tap** on page 135.

HOTSHOT 1 FILTERED KETTLE HOT WATER



Hotshot 1 Filtered Kettle Hot
Ref. HOT1CP Chrome **£399**
Ref. HOT1BN
Brushed Nickel PVD **£449**
Included: Thermostatic Boiler,
Filter Cartridge and Connectors
WRAS Approved

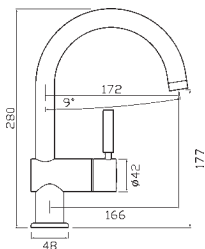

Brushed Nickel PVD



Chrome



Chrome

HOTSHOT 2 FILTERED KETTLE HOT & COLD PURE DRINKING WATER



Brushed Nickel PVD

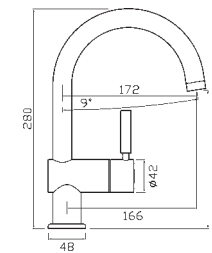

Hotshot 2 Filtered Kettle
Hot and Filtered Cold
Ref. HOT2CP Chrome **£469**
Ref. HOT2BN
Brushed Nickel PVD **£489**
Included: Thermostatic Boiler,
Filter Cartridge and Connectors
WRAS Approved



FILTER CARTRIDGE

The filter cartridge included has a 6 month life span and a capacity of 3800 litres.

Replacement Cartridges
Ref. F6C1 - £72
WRAS Approved

An optional filter with a 12 month life span is also available with a capacity of 7600 litres.

Ref. F12C1 - £112
WRAS Approved

LONGDON 4

The **Longdon** hides some very smart tech behind its softly sculptured exterior - its 4 in 1 technology is controlled by two elegant ceramic levers, these dispense 98 degree hot and cold filtered water for drinks and cooking as well as a standard domestic hot/cold supply. The curvy aesthetic of the Longdon allows this versatile tap to be at home in both modern and traditional settings and with its ceramic levers make a perfect alliance with fireclay sinks. It is available with an incredibly useful matching handspray, see page 207 for more info.

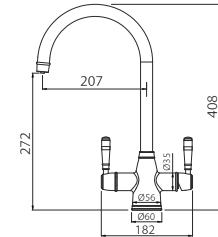
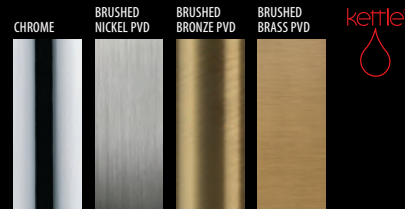

Longdon 4 in 1 Traditional

- Ref. **LON4CP** Chrome £799
- Ref. **LON4BN** Brushed Nickel PVD £835
- Ref. **LON4BB** Brushed Brass PVD £835
- Ref. **LON4BZ** Brushed Bronze PVD £859

Included: Thermostatic Boiler, Filter Cartridge and Connectors

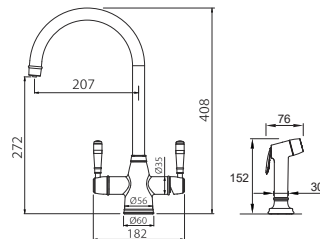

Longdon 4 in 1 Traditional with Dual Pull-Out Spray

- Ref. **LONR4CP** Chrome £908
- Ref. **LONR4BN** Brushed Nickel PVD £959
- Ref. **LONR4BB** Brushed Brass PVD £968
- Ref. **LONR4BZ** Brushed Bronze PVD £997

Included: Thermostatic Boiler, Filter Cartridge and Connectors



Brushed Nickel PVD

Traditional Pull-Out Spray in Brushed Nickel - see page 207

FUNCTIONS

- **4 Functions** - domestic hot, domestic cold, 98°C filtered water and cold filtered water.
- **2 Stage Child Safe operation** - press down unlock and spring loaded lever dispenses 98°C filtered water.
- **Cool touch spout** - centrally insulated 98°C channel ensuring spout remains safe to touch.
- **Advanced filtration** - protects the boiler from lime-scale formation, removes contaminants and improves taste and odour of the water to achieve the perfect hot & cold drinks.

FILTER CARTRIDGE

The filter cartridge included has a 6 month life span and a capacity of 3800 litres.

Replacement Cartridges
Ref. **F6C1** - £72 - WRAS Approved

An optional filter with a 12 month life span is also available with a capacity of 7600 litres.

Ref. **F12C1** - £112 - WRAS Approved



DIGITAL THERMOSTATIC BOILER

- **2.4 Litre capacity** - instant kettle hot water, capable of providing 60 cups per hour.
- **Simple installation** - non-specialist fitting uses standard 13 amp plug.
- **Anti-scale filter provided** - reduces lime-scale and improves water quality.
- **State-of-the-art Digital controls** - accurate to 0.5 degrees variable.
- **10 temperature settings** - from 45° to 98°.
- Operates from 1.5 bar.
- Ultra compact design.
- Automated Filter Reminder System.
- 2 year warranty.

Boiler Dimensions

Width 188mm
Depth 188mm
Height 270mm



FILTER TAPS



TAP INTO HEALTHIER GREAT TASTING FILTERED WATER

The filtered water tap is fast becoming a common feature in today's modern kitchen.

The high performance filters transform standard tap water into fresh clean tasting drinking water so efficiently that the filtered water cannot be distinguished from bottled mineral water.

The cost saving is considerable compared to purchasing bottled water and also saves time and energy carrying heavy bottles from the supermarket. Using a filtered tap is also environmentally friendly thus avoiding the disposal of endless plastic bottles.

FILTER TAP

BENEFITS

TASTE

The Pure Filter removes impurities to give the water a great taste to rival bottled mineral water. The filtration transforms tap water giving a pure untainted taste.

HEALTH

Drinking filtered water with all impurities removed and the healthy minerals left adds to the health-giving properties compared to standard tap water.

CHILLED

Our chilled units can further add to the pleasure of filtered refreshing water, simple to fit under the sink giving constant chilled/ filtered water.



Pure Chiller 100

ENVIRONMENT

Aside from the inconvenience of carrying heavy bottles home from the supermarket, there is the added benefit of not adding to the growing plastic waste epidemic that is choking our planet.

ECONOMY

Why spend a fortune on bottled water when equally good tasting water is simply on tap and virtually free to use.

APPLIANCES

Prolong the life of your steam iron and kettle by filling with filtered water to avoid limescale build-up.

FILTER REPLACEMENT

To maintain a supply of great tasting water it is important to replace the filter after 4000 litres have been used, we supply, with each tap, a Pure FlowPro digital reader which will remind you when it's time to change. It is easy to replace the filter by a simple twist off and twist on process, no plumbing skill required!



P6C1 Filter

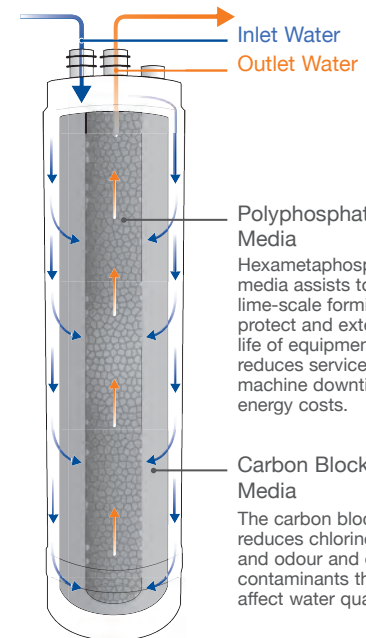

Pure FlowPro water meter

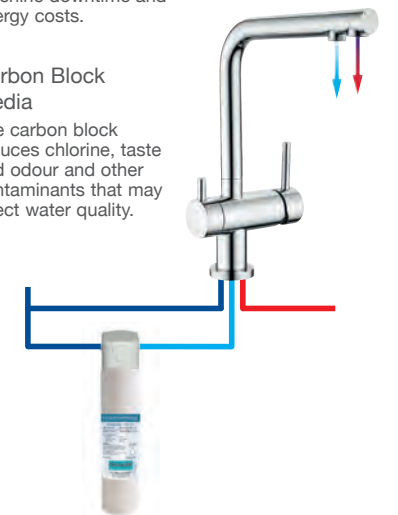

FILTER



For chilled filtered water see our **Chiller** on page 159.



The **Pure FlowPro** is a digital Filter replacement reminder system with live flow rate.

Included with all Filter Taps.

The Filter

Each Clearwater filter delivers 3800 litres of filtered water at a fraction of the price of bottled water. Untainted by the taste of heavy metals, limescale and chlorine results in fresh, great tasting water straight from the tap.

NSF REG4 Approved

Replacement Cartridges Ref. P6C1 - £55



Matt Black

MARINER

The synergy of form and function has resulted in a tap with understated elegance and great functionality. The **Mariner's** quiet good looks conceal the latest valve technology - Hot/Cold water is controlled by the stylish lever on the right and cold filtered water is operated by the subtly hidden press-control on the left.

Ref. MAL10CP Chrome £336

Ref. MAL10BN Brushed Nickel PVD £358

Ref. MAL10MB Matt Black £369

Ref. MAL10BB Brushed Brass PVD £380

Included: Filter Cartridge, Connectors and Pure FlowPro
WRAS Approved

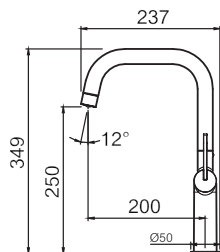

Chrome

TAPS FILTER

- PVD COATING
Helps to withstand surface damage and provides a more hygienic surface
- CONCEALED FILTER CONTROL
provides seamless aesthetic minimalism

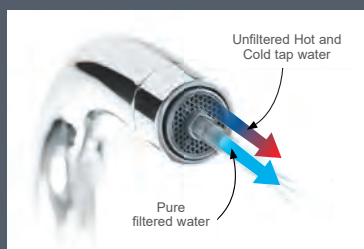

Chrome



Brushed Nickel PVD



Matt Black

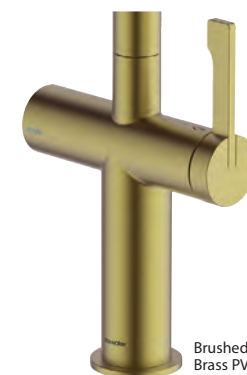

Brushed Brass PVD

FILTER PULL-OUT pure



The **Pure FlowPro** is a digital Filter replacement reminder system with live flow rate. **Included with all Filter Taps.**



For chilled filtered water see our **Chiller** on page 159.



ROSETTA

The **Rosetta's** flowing lines provide a truly 21st century aesthetic. This ultra-modern tap is packed with clever tech that allows for great task flexibility.

Ref. ROL10CP

Chrome **£336**

Ref. ROL10BN

Brushed Nickel PVD **£358**

Ref. ROL10MB

Matt Black **£369**

Ref. ROL10BB

Brushed Brass PVD **£380**

Included: Filter Cartridge, Connectors and Pure FlowPro
WRAS Approved

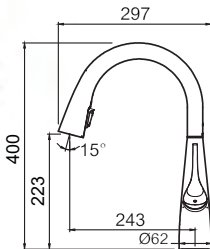
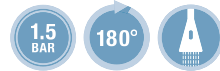

Matt Black



Chrome



Brushed Nickel PVD



Matt Black



Brushed Brass PVD

- **CONCEALED PULL-OUT SPRAYHEAD**
Easy pull-out spray-head is invisibly concealed within the spout
- **TWO-FUNCTION SPRAYHEAD**
Button control allows you to switch from aerated to spray
- **SEPARATE FILTERED WATER OUTLET**
Avoids cross-contamination with mixed water
- **PVD COATING**
Helps to withstand surface damage and provides a more hygienic surface



Black sprayhead is hidden under the concealed pulldown

TOLEDO

The **Toledo** Mixer/Filter tap boasts an understated aesthetic with a pull-out spout discreetly engineered to enhance its minimalist credentials.

Ref. TO2CP

Chrome **£369**

Ref. TO2BN

Brushed Nickel PVD **£425**

Ref. TO2MB

Matt Black **£437**

Ref. TO2BB

Brushed Brass PVD **£437**

Included: Filter Cartridge, Connectors and Pure FlowPro

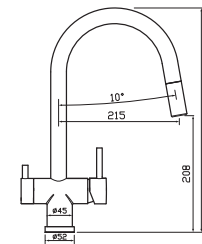

Brushed Brass PVD



Pull-out spray extends to 30cm

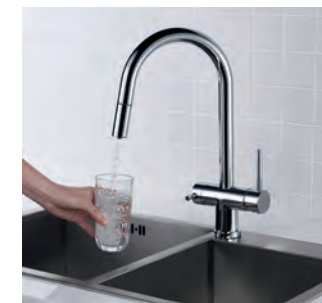

Separate filtered water outlet

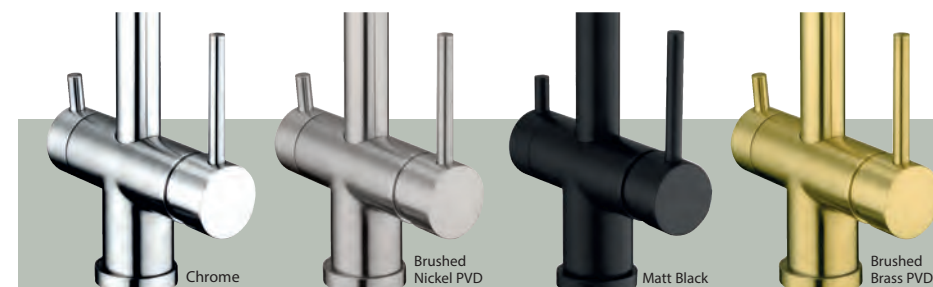

Chrome

Brushed Nickel PVD

Matt Black

Brushed Brass PVD

PVD COATING
Helps to withstand surface damage and provides a more hygienic surface



Icons Explained see page 131.

FILTER PRO pure



The **Pure FlowPro** is a digital Filter replacement reminder system with live flow rate. **Included with all Filter Taps.**



For chilled filtered water see our **Chiller** on page 159.

Galex Motion
For the Sensor version of the Galex tap see page 160-161.



Matt Black

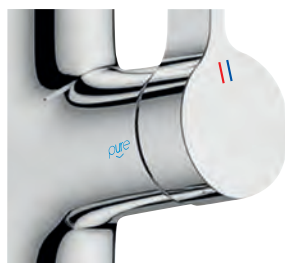

3-Way Lever
The universal 3-way lever operates pure filtered and domestic hot and cold water

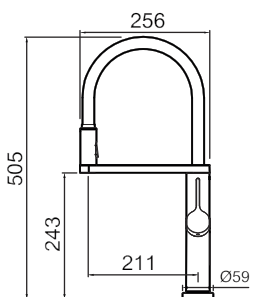

GALEX

The **Galex** is the next generation of Professional taps combining a minimalist design with multiple task possibilities. The single control dispenses standard hot/cold water and great tasting filtered cold water. The detachable showerhead offers 360° flexibility for food prep and rinsing down.

Ref. GAL20CP
Chrome **£369**

Ref. GAL20MB
Matt Black **£403**

Included: Filter Cartridge, Connectors and Pure FlowPro
WRAS Approved



- **EASY-DOCK SPRAYHEAD**
Magnetic docking sprayhead simply lift off to direct flow 360 degrees
- **TWO-FUNCTION SPRAYHEAD**
Button control allows you to switch from aerated to spray
- **SEPARATE WATER OUTLETS**
Avoids cross-contamination mixed water
- **PVD COATING**
Helps to withstand surface damage and provides a more hygienic surface
- **SILICON FLEXIBLE HOSE**
Totally flexible silicon heat resistant easy clean hose



Chrome



Icons Explained see page 131.

FILTER PRO pure

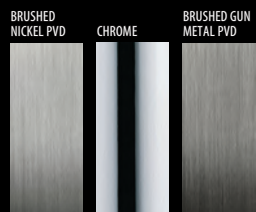

White & Brushed Nickel PVD



Red & Chrome



Grey & Gun Metal PVD

BELLATRIX

The **Bellatrix** is a professional style filter tap offering the ever useful detachable and directional silicon spout which offers two spray modes for rinsing and filling.

The swivel retaining arm also contains its own water conduit for filtered water with its outlet neatly positioned behind the main spout. The Bellatrix is supplied as standard with a black silicon hose and there is a choice of white, grey and red hoses that can be purchased separately to colour tone with your kitchen.



Black & Brushed Nickel PVD

HOSE COLOURS

Black (included with tap)

BEWT White £29

BEGT Grey £29

BERT Red £29



The **Pure FlowPro** is a digital Filter replacement reminder system with live flow rate.

Included with all Filter Taps.



For chilled filtered water see our **Chiller** on page 159.

Black & Gun Metal PVD

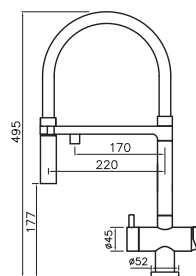

Bellatrix Professional mixer with detachable silicon spout, twin spray head and cold Filter.

Ref. BE4CP Chrome/Black £449

Ref. BE5BN Brushed Nickel PVD/Black £489

Ref. BE7GM Gun Metal PVD/Black £489

Included: Filter Cartridge, Connectors and Pure FlowPro

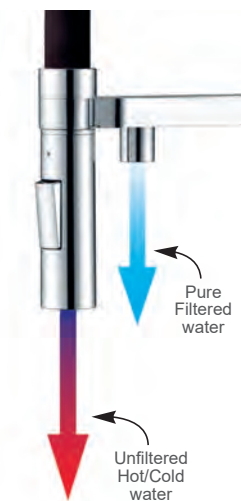

FILTER pure[®] TRI-SPA

The **Tri-Spa** range of taps are based on the original three lever control design, each lever operates its own waterway and is delightfully simple to operate. The domestic hot and cold are in the usual side positions and the filtered water is controlled by the central lever. All models have separated filtered water conduits to avoid any mixing with unfiltered water.

There are three design choices; the **Stella** for crisp minimalism on these pages, the **Eclipse** for soft flowing lines and the **Krypton** for a more nostalgic style on the following pages.



Brushed Brass PVD



For chilled filtered water see our **Chiller** on page 159.

Matching Wastes available see page 126



Icons Explained see page 131.

TAPS FILTER

The **Pure FlowPro** is a digital Filter replacement reminder system with live flow rate.
Included with all Filter Taps.

Unfiltered Hot and Cold tap water
Pure filtered water

Filtered Water Control Lever

Brushed Nickel PVD

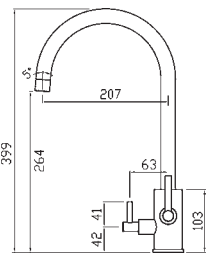

STELLA TRI-SPA

Stella Tri-Spa mixer and cold Filter with 'C' swivel spout.

Ref. ST2CP Chrome £337

Ref. ST2BN Brushed Nickel PVD £388

Ref. ST2MB Matt Black £409

Ref. ST2BB Brushed Brass PVD £409

Included: Filter Cartridge, Connectors and Pure FlowPro



Matt Black

STELLA FINISHES

PVD COATING Helps to withstand surface damage and Nano technology provides a more hygienic surface



FILTER TRI-SPA



For chilled filtered water see our **Chiller** on page 159.

Matching Wastes available see page 126



The **Pure FlowPro** is a digital Filter replacement reminder system with live flow rate. **Included with all Filter Taps.**



Brushed Nickel PVD

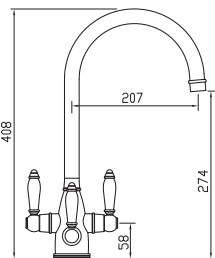

KRYPTON TRI-SPA

Krypton Tri-Spa mixer and cold Filter with 'C' swivel spout.

Ref. KR2CP Chrome **£337**

Ref. KR2BN Brushed Nickel PVD **£388**

Ref. KR2BZ Brushed Bronze **£409**

Ref. KR2BB Brushed Brass PVD **£409**

Included: Filter Cartridge, Connectors and Pure FlowPro



Brushed Brass PVD

KRYPTON FINISHES

PVD COATING Helps to withstand surface damage and provides a more hygienic surface



Chrome

Brushed Nickel PVD

Brushed Bronze

Brushed Brass PVD



Brushed Nickel PVD

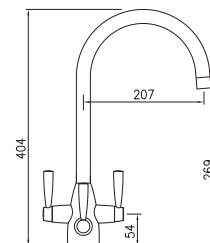

ECLIPSE TRI-SPA

Eclipse Tri-Spa mixer and cold Filter with 'C' swivel spout.

Ref. EC2CP Chrome **£337**

Ref. EC2BN Brushed Nickel PVD **£388**

Included: Filter Cartridge, Connectors and Pure FlowPro



Icons Explained see page 131.



Chrome

ECLIPSE FINISHES

PVD COATING Helps to withstand surface damage and provides a more hygienic surface

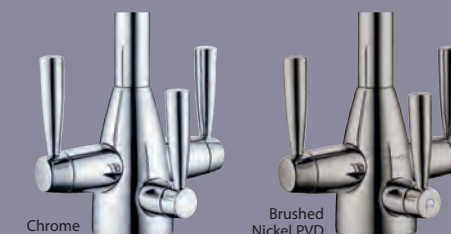

Chrome

Brushed Nickel PVD

FILTER pure



The **Pure FlowPro** is a digital Filter replacement reminder system with live flow rate.
Included with all Filter Taps.

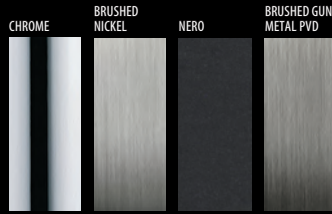

For chilled filtered water see our **Chiller** on page 159.

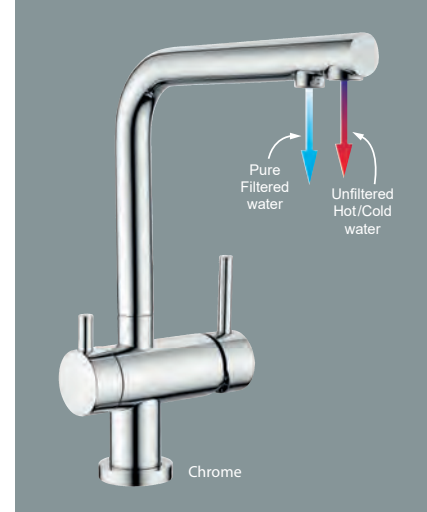

NESO

An elegant swan neck spout mixer that will suit both contemporary and traditional settings.

Neso mixer and cold Filter with 'C' swivel spout.

Ref. NE2CP Chrome **£298**

Included: Filter Cartridge, Connectors and Pure FlowPro

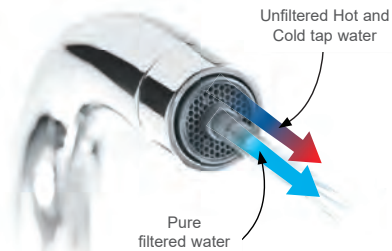
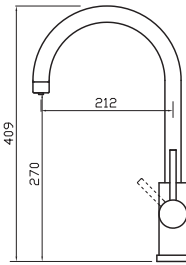

HYDRA

The **Hydra** is very chic 'L' spout mixer available in the usual chrome but also a sophisticated Nero finish to synchronise with matching granite sinks and black appliances.

Hydra mixer and cold Filter with 'L' swivel spout.

Ref. HY2CP Chrome **£324**

Ref. HY2NE Chrome/Nero **£380**

Included: Filter Cartridge, Connectors and Pure FlowPro

REG4 Approved

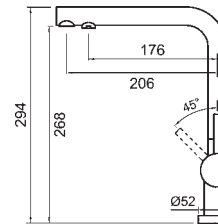

TAPS FILTER

ALPHA

The Alpha top lever modern design is a minimalist classic with the bonus of filtered water operated by the side control.

Alpha top lever mixer and cold Filter with swivel spout.

Ref. ALP2BN Brushed Nickel **£196**

Included: Filter Cartridge, Connectors and Pure FlowPro

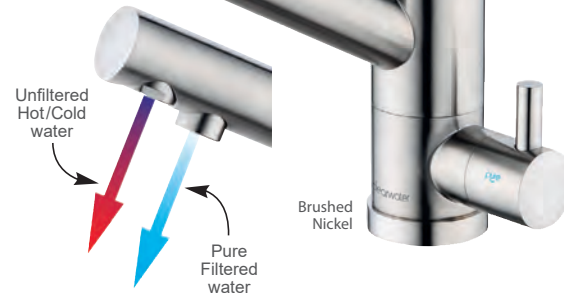
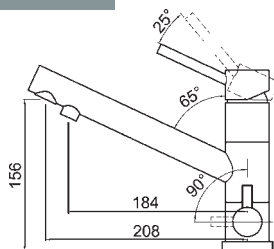

MALIN

Malin mixer and cold Filter with 'L' swivel spout.

Ref. MA2GM Brushed Gun Metal PVD **£513**

Included: Filter Cartridge, Connectors and Pure FlowPro

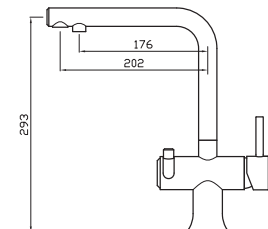

FILTER pure[®] STAINLESS STEEL



The **Pure FlowPro** is a digital Filter replacement reminder system with live flow rate.
Included with all Filter Taps.



For chilled filtered water see our **Chiller** on page 159.

BRUSHED STAINLESS STEEL



AQUARIUS

Aquarius mixer and cold Filter with 'C' swivel spout.

Ref. AQ2SS Stainless Steel **£427**

Included: Filter Cartridge, Connectors and Pure FlowPro

REG4 Approved

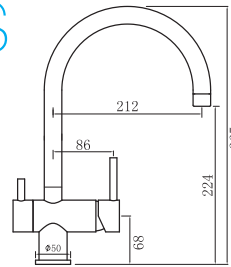

ZUBEN

A sleek cruciform style filter tap in solid stainless steel providing a wonderful enduring lustre.

Zuben mixer and cold Filter with 'L' swivel spout.

Ref. ZU2SS Stainless Steel **£459**

Included: Filter Cartridge, Connectors and Pure FlowPro

REG4 Approved

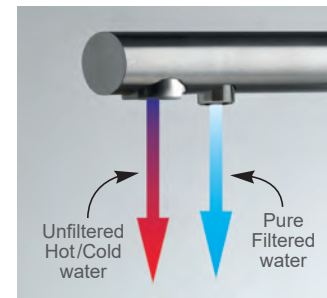
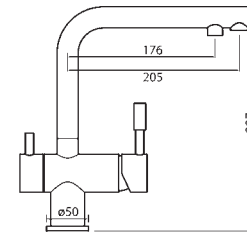

TAPS FILTER STAINLESS STEEL

FILTERED WATER SIPHON

This compact siphon delivers cold filtered water **only** and is perfect to work in conjunction with a regular mixer tap.

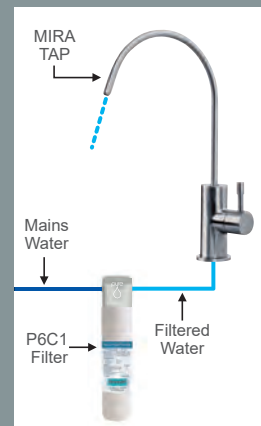

MIRA

Mira single flow cold Filter tap with 'C' spout.

Ref. MI2SS Stainless Steel **£197**

Included: Filter Cartridge, Connectors and Pure FlowPro

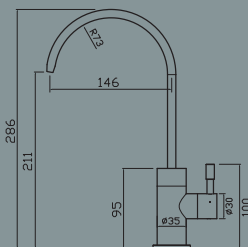

PURE CHILLER 100 pure[®]



For superior tasting water, the **Pure Chiller 100** is an additional feature that can be combined with any of our filter taps. It has a patented silver turbo clean system which generates a water vortex on the internal walls whenever water is dispensed, so preventing biofilm formation. In addition, the sealed stainless steel cooling chamber is welded together using silver, a material well known for its antibacterial properties.

Thus providing pure crisp chilled water on demand directly from your tap.

- Icebank system for superior chilling
- Simple & quick installation
- Compact design
- Up to 15 litres per hour of chilled water - between 3° and 10° C
- 1.5 bar minimum
- Width 26cm
Depth 23.5cm
Height 40.7cm
- 2 year warranty

Ref. Pure100 **£799**



SENSOR TAPS

Sensor taps free-up your hands so you can speed through daily chores such as washing, cleaning and food prep whilst maintaining a more hygienic environment. No need to touch the tap when your hands are full or you have been prepping raw meat - just a simple wave of your hand or an object such as a pan or a utensil will activate the sensor to turn the water flow on and a further movement within 10cm of the sensor will turn it off.

These state-of-the-art taps are an invaluable kitchen assistant that will create a more germ-free work zone.

- **INTELLIGENT MOTION TECHNOLOGY**
Reliable touchless on/off operation
- **PRECISE ACTIVATION ZONE**
Utilises state-of-the-art sensor to prevent false activations
- **DUAL OPERATION**
Optional manual and Touchless control
- **BATTERY OPERATED**
No power supply necessary

- **PVD COATING**
Helps to withstand surface damage and Nano technology provides a more hygienic surface
- **Energy saving cold-start control**



Galex Filter
See the filter version of the Galex tap on page 148.

GALEX MOTION



The **Galex Motion** touchless tap combines beautiful design and smart technology which enables you to speed through tasks at the sink without having to touch the tap thus avoiding the spread of germs. The Motion™ technology will respond by a simple movement of a hand or object. The sensor operates within 10cm to avoid unintentional activation.

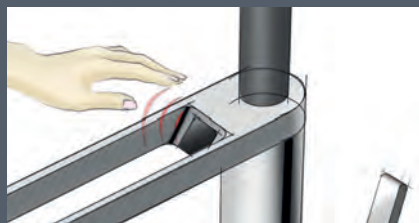

Sensor operated



Multi-directional

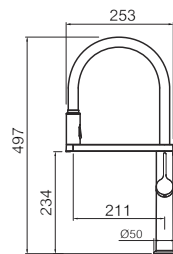
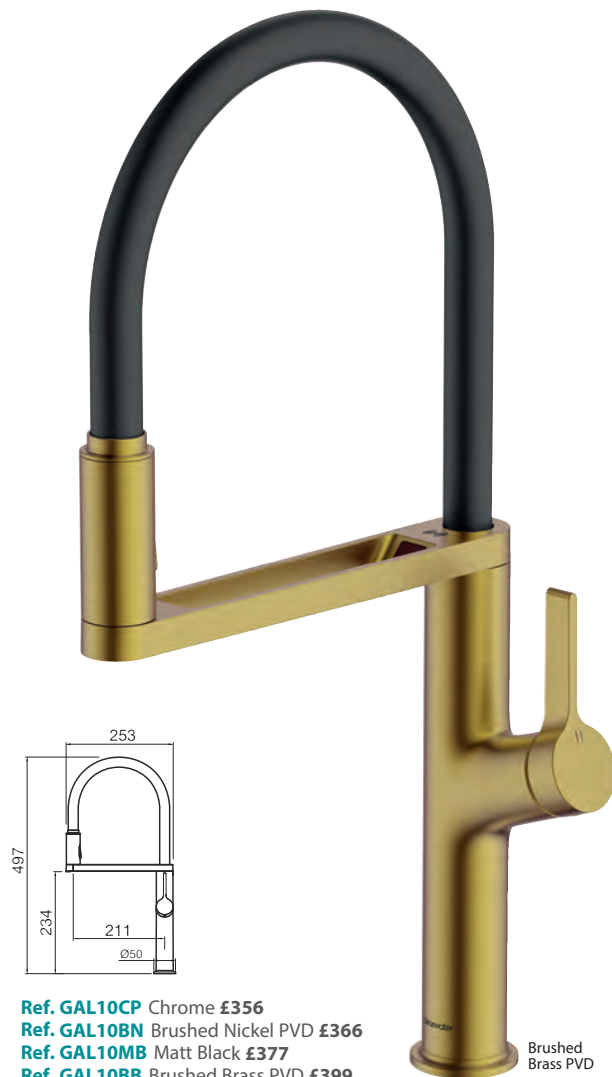

- Ref. **GAL10CP** Chrome £356
- Ref. **GAL10BN** Brushed Nickel PVD £366
- Ref. **GAL10MB** Matt Black £377
- Ref. **GAL10BB** Brushed Brass PVD £399

WRAS Approved



- **EASY-DOCK SPRAYHEAD**
Magnetic docking sprayhead simply lift off to direct flow 360 degrees
- **TWO-FUNCTION SPRAYHEAD**
Button control allows you to switch from aerated to spray

Hot and Cold indices on lever

Sensor situated at base of spout

Two function spray-head

TAPS MOTION SENSOR



AMELIO

SENSOR

- BATTERY OPERATED
No power supply necessary
- Energy saving cold-start control

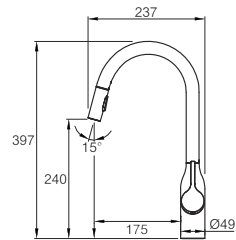

AMELIO PULL-OUT

The **Amelio** is a most elegant tap with flowing lines and versatile functions, including a smooth action pull-out hand spray with dual flow options and a motion sensor positioned at its front base for touchless control when required. As with all our Sensor taps, water can be controlled both manually and by sensor.

- Ref. AML10CP** Chrome £323
 - Ref. AML10BN** Brushed Nickel PVD £334
 - Ref. AML10MB** Matt Black £345
 - Ref. AML10BB** Brushed Brass PVD £355
- WRAS Approved

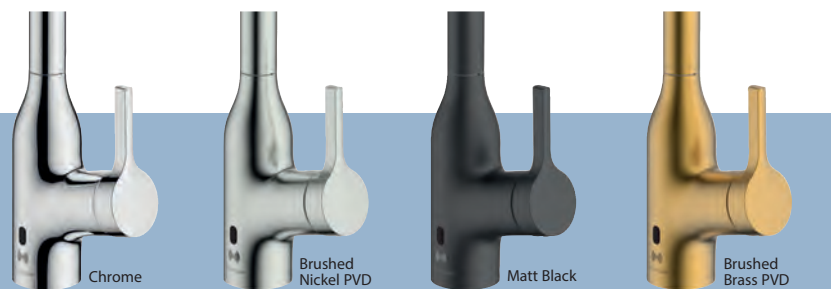
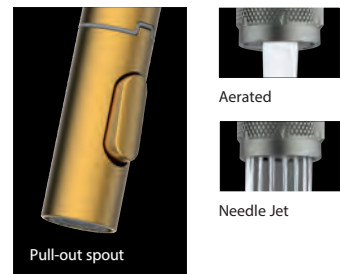

PVD COATING
Helps to withstand surface damage and provides a more hygienic surface

AZIA

SENSOR

- BATTERY OPERATED
No power supply necessary
- Energy saving cold-start control



Matching Wastes available
see page 126

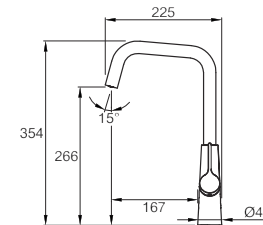

AZIA

The **Azia** has very progressive styling with an asymmetric body design, part curved, part flat with its motion sensor located on the left face - a simple movement within 10cm will activate the flow.

As with all our Sensor taps water can be controlled manually and by sensor.

- Ref. AZL10CP** Chrome £344
 - Ref. AZL10BN** Brushed Nickel PVD £345
 - Ref. AZL10MB** Matt Black £356
 - Ref. AZL10BB** Brushed Brass PVD £373
- WRAS Approved

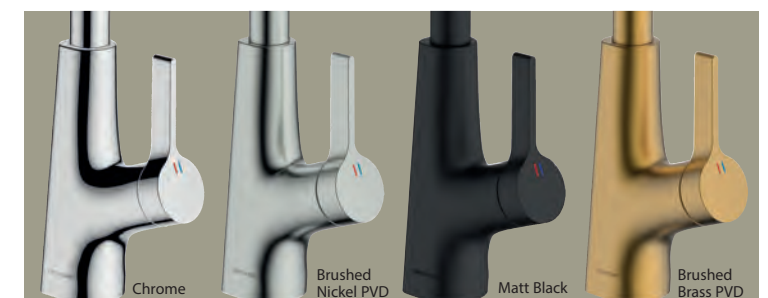

TWIST & SPRAY®

These taps are fitted with the unique **Twist & Spray** aerator which provides two flow types that can be changed with a simple twist of the flange. The pleasing high quality movement clicks from a non-splash aerated flow to a needle jet-spray that is ideal for jobs such as rinsing plates and food preparation. The needle-jet mode can also generate detergent bubbles far more easily than an aerated flow, particularly in today's water regulated taps.

The Twist & Spray has greatly widened the standard tap's range of abilities in one simple twist.

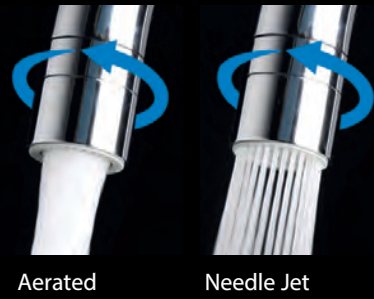

Chrome

SAVITA

The **Savita** boasts sharp cylindrical geometry combined with faultless technology, it's spout incorporates a Twist & Spray Aerator to suit multiple kitchen chores.

Ref. SA2CP Chrome **£228**

Ref. SA2BN Brushed Nickel PVD **£270**

WRAS Approved

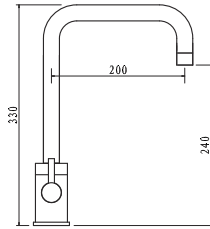

SIREN

The **Siren** pragmatic assured design, it's spout incorporates a Twist & Spray Aerator to suit multiple kitchen chores.

Ref. SI81045CP Chrome **£143**

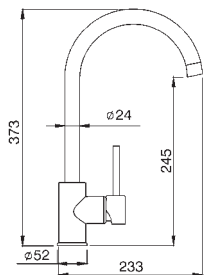

Chrome

Brushed Nickel PVD



Chrome

ZODIAC

The **Zodiac's** cosmopolitan design fits with most kitchen types, it comes loaded with the latest tech making them an ideal choice for fault-free longevity. The Z04 is supplied with anti-scale SLC aerator which helps prevent limescale build up.

The Z02 and Z03 incorporate Twist & Spray aerators to suit multiple kitchen chores.

All models are WRAS approved.

- Energy saving cold-start control

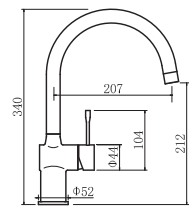
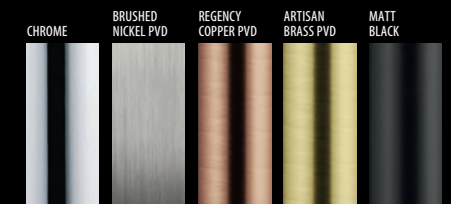

Ref. Z02CP Chrome **£170**

Ref. Z02BN Brushed Nickel PVD **£186**

WRAS Approved

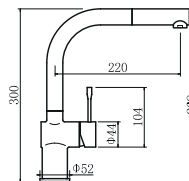

Ref. Z04CP Chrome **£170**

Ref. Z04BN Brushed Nickel PVD **£186**

The Zodiac Z04 tap is not fitted with the Twist & Spray Aerator

WRAS Approved



Chrome

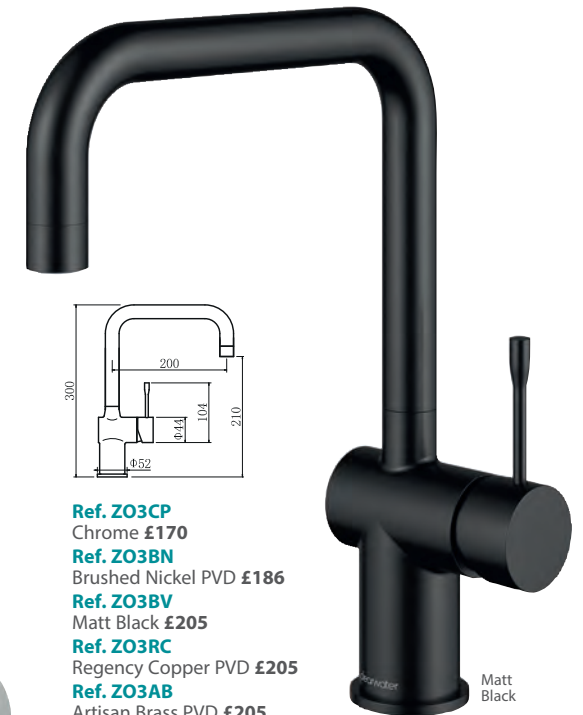

Matt Black

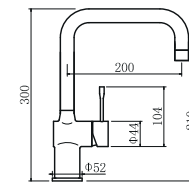

Ref. Z03CP Chrome **£170**

Ref. Z03BN Brushed Nickel PVD **£186**

Ref. Z03BV Matt Black **£205**

Ref. Z03RC Regency Copper PVD **£205**

Ref. Z03AB Artisan Brass PVD **£205**

WRAS Approved



Icons Explained see page 131.



Matching Wastes available see page 126.

TWIST & SPRAY™ TOPAZ

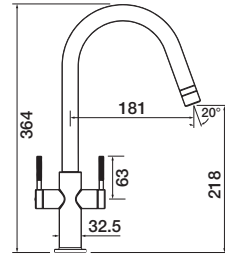
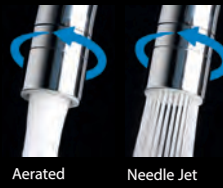

TOPAZ J SPOUT

The **Topaz** boasts a slimline design with minimalist high-set knurled controls. Both spout types incorporate Twist & Spray Aerators to suit multiple kitchen chores.

- Ref. TOP20BN**
Brushed Nickel PVD **£258**
 - Ref. TOP20MB**
Matt Black **£269**
 - Ref. TOP20BB**
Brushed Brass PVD **£280**
- WRAS Approved



Topaz Pull-out
See the pull-out version of the Topaz tap on page 188.

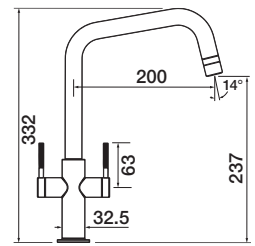

TOPAZ U SPOUT

- Ref. TOP10BN**
Brushed Nickel PVD **£237**
 - Ref. TOP10MB**
Matt Black **£248**
 - Ref. TOP10BB**
Brushed Brass PVD **£258**
- WRAS Approved



Aerated - Brushed Nickel PVD



Needle Jet - Brushed Nickel PVD



PVD COATING
Helps to with-stand surface damage and provides a more hygienic surface

Brushed Nickel PVD Matt Black Brushed Brass PVD



Aerated - Matt Black



Needle Jet - Matt Black

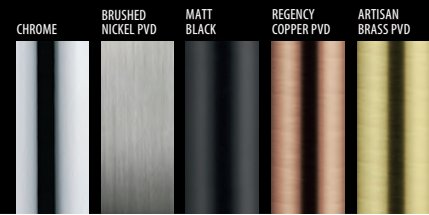

TWIST & SPRAY™ ROCOCO

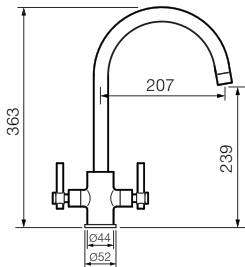
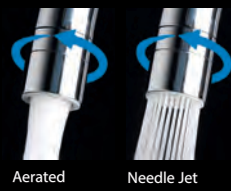

ROCOCO

The **Rococo** is an uncompromising cylindrically shaped tap that offers urban chic in buckets, it's spout incorporates a Twist & Spray Aerator to suit multiple kitchen chores.

- Ref. ROC2CP** Chrome £247
 - Ref. ROC2BN** Brushed Nickel PVD £297
 - Ref. ROC2MB** Matt Black £297
 - Ref. ROC2RC** Regency Copper PVD £297
 - Ref. ROC2AB** Artisan Brass PVD £297
- WRAS Approved



PVD COATING
Helps to withstand surface damage and provides a more hygienic surface

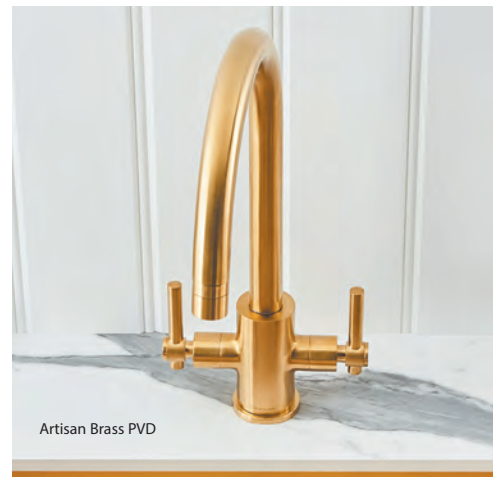
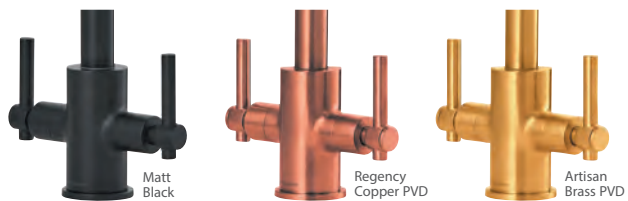

Matching Wastes available see page 126.

TUTTI



Matt Black



Icons Explained see page 131.

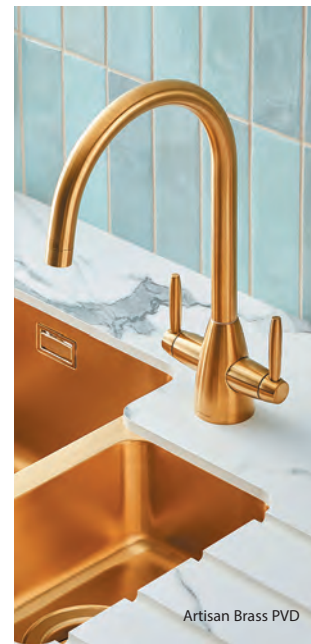

Artisan Brass PVD

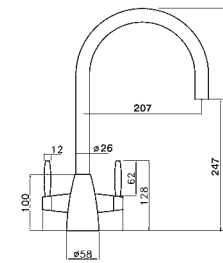

TUTTI

The **Tutti** features tapering base and controls that exude a simple charm, it's spout incorporates a Twist & Spray Aerator to suit multiple kitchen chores.

- Ref. TU81073CP** Chrome £241
- Ref. TU81073BS** Brushed Nickel PVD £259
- Ref. TU81073BV** Matt Black £259
- Ref. TU81073RC** Regency Copper PVD £259
- Ref. TU81073AB** Artisan Brass PVD £259

WRAS Approved



PVD COATING
Helps to withstand surface damage and provides a more hygienic surface



TWIST & SPRAY[®] DAVINA

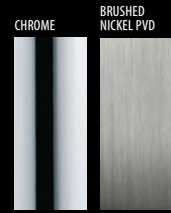
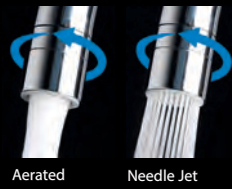

Matching Wastes available see page 126.

ALZIRA

The **Alzira's** contemporary design with its fluid soft architecture allow it to be at home in both modern and traditional interiors. The colour choices and spout style options make sure this great tap can match to most tastes.



Chrome

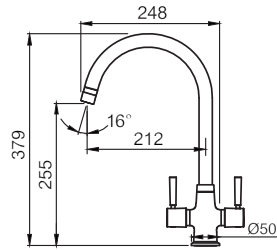

DAVINA

The **Davina** will suit most kitchen styles with its subtle retro styling it's spout incorporates a Twist & Spray Aerator to suit multiple kitchen chores.

Ref. DA20CP
Chrome £224

Ref. DA20BN
Brushed Nickel PVD £234

WRAS Approved



Brushed Nickel PVD



Brushed Copper

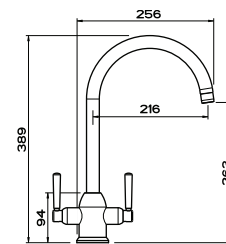

Ref. ALZCP Chrome £261

Ref. ALZBS Brushed Nickel £293

Ref. ALZBC Brushed Copper £303

WRAS Approved



Chrome

Ref. CAMCP
Chrome £261

Ref. CAMBS
Brushed Nickel £293

Ref. CAMCC
Brushed Copper £303

WRAS Approved

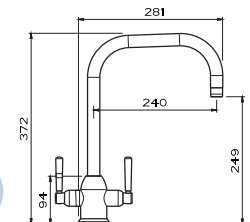

Icons Explained see page 131.

JUNO



Matching Wastes available see page 126.

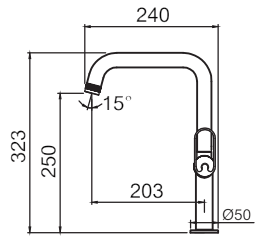

JUNO

The **Juno** boasts a slimline modern design with high-set controls, its precision construction and the latest valve technology will ensure faultless service. This progressive tap announces its industrial aesthetics with a futuristic control handle and knurling on the valve cover. The Juno is available in four fabulous finishes to coordinate or contrast with your choice of kitchen fittings.

- Ref. JUL10CP** Chrome **£185**
- Ref. JUL10BN** Brushed Nickel PVD **£205**
- Ref. JUL10MB** Matt Black **£215**
- Ref. JUL10BB** Brushed Brass PVD **£225**

WRAS Approved

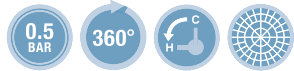

- **PVD COATING**
Helps to withstand surface damage and provides a more hygienic surface
- **SLC AERATOR**
Offers anti-limescale features, has a rubber face to prevent scale amalgamation
- **Energy saving cold-start control**



Brushed Brass PVD



Chrome

Brushed Nickel PVD

Matt Black

Brushed Brass PVD

PIONEER



Matching Wastes available see page 126.

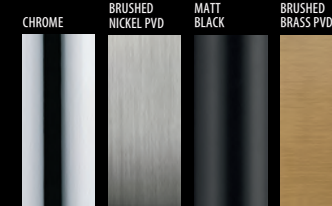

Pioneer Pull-Out
See the pull-out version of the Pioneer tap on page 192



Brushed Nickel PVD

PIONEER

The **Pioneer** taps boast urban good looks with edgy industrial elements – a perfect fit for the warehouse apartment look. Distinct features include knurled components and retro steam-valve controls.

- Ref. PIL20CP** Chrome **£185**
- Ref. PIL20BN** Brushed Nickel PVD **£205**
- Ref. PIL20MB** Matt Black **£215**
- Ref. PIL20BB** Brushed Brass PVD **£225**

WRAS Approved

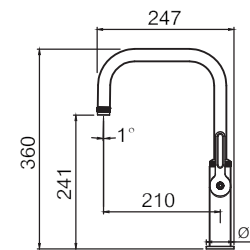

Chrome

Brushed Nickel PVD

Matt Black

Brushed Brass PVD



Icons Explained see page 131.

- **PVD COATING**
Helps to withstand surface damage and provides a more hygienic surface
- **Energy saving cold-start control**



Levant Pull-out
The Levant is available in a versatile Pull-out version see page 186.

LEVANT



Matching Wastes available
see page 126.

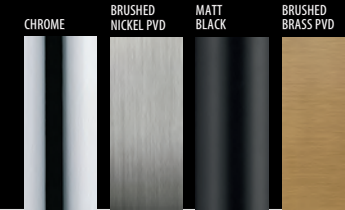

TAKU

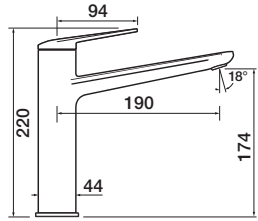

LEVANT

The **Levant's** Swiss architectural design provides effortless good looks that perfectly suit pairing with undermount sinks for sleek minimalism. The robust structure features a beautifully sculptured broad spout with a wide blade control lever that compliments the Levant's design ethos.

- Ref. LEV10CP** Chrome £215
- Ref. LEV10BN** Brushed Nickel PVD £226
- Ref. LEV10MB** Matt Black £237
- Ref. LEV10BB** Brushed Brass PVD £248

WRAS Approved



Chrome



Brushed Brass PVD



Levant's unique wide blade control lever



Levant Aerator
Slim Air Cascade with adjustable tilting plate (SSR) and Smart Lime Cleaning (SLC)

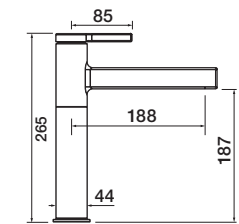

TAKU

The **Taku's** unique design elements, include a vertical linear swivel spout that produces an attractive blade shaped water flow. The top control has an attractive slim profile that compliments the Taku's quirky minimalist qualities.

- Ref. TAK10CP** Chrome £204
- Ref. TAK10BN** Brushed Nickel PVD £215
- Ref. TAK10MB** Matt Black £226
- Ref. TAK10BB** Brushed Brass PVD £237

WRAS Approved



Taku Water Flow
Laminar stream straighteners produce a non-aerated water stream. Ideal for high-flow applications or health care facilities (no mix of water/air).



Brushed Brass PVD

?
Icons Explained see page 131.

PVD COATING
Helps to withstand surface damage and provides a more hygienic surface



Chrome

Brushed Nickel PVD

Matt Black

Brushed Brass PVD

PVD COATING
Helps to withstand surface damage and provides a more hygienic surface

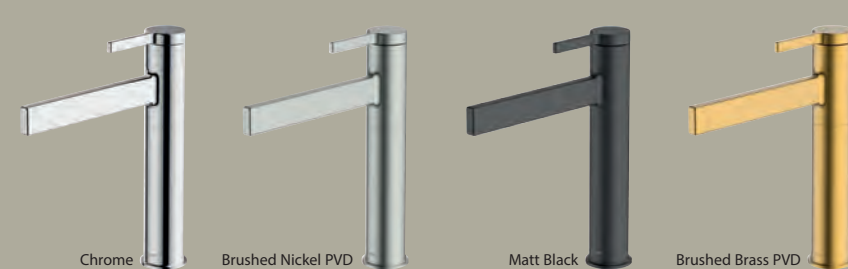

Chrome

Brushed Nickel PVD

Matt Black

Brushed Brass PVD



Black & Brushed Brass PVD

MORPHO

The **Morpho** is an ideal choice of tap for multi-tasking with its Flex & Stay spout. This unique spout can be bent and shaped and will remain frozen in position so that the spray can be directed precisely, leaving hands free for the task in hand. The spout can be pulled low into the sink for food preparation and swept around the walls of the sink for rinsing down, making the Morpho a worthy kitchen assistant.

Available in Chrome, Brushed Nickel, Brushed Brass and Matt Black with a choice of four stylish silicon spout colours for complimenting the kitchen colour scheme.

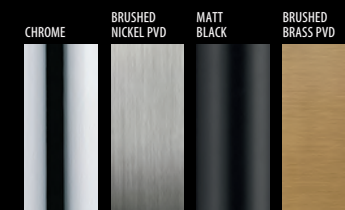

Icons Explained see page 131.

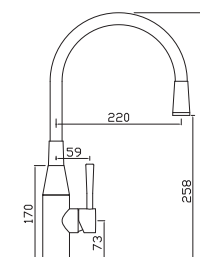

Ref. MO2CP**
Chrome/Black £230

Ref. MO2BN**
Brushed Nickel PVD/Black £249

Ref. MO2BB**
Brushed Brass PVD/Black £269

Ref. MO2MB**
Matt Black/Black £269



Hose Colours
The Morpho is supplied with a Black silicon hose, Red, Grey and White hoses are available at an extra charge.

● **RT** Red Hose £29

● **GT** Grey Hose £29

○ **WT** White Hose £29

(** add hose colour suffix if required)



Black & Chrome

- **PVD COATING**
Helps to withstand surface damage and provides a more hygienic surface
- **SLC AERATOR**
Offers anti-limescale features, has a rubber face to prevent scale amalgamation
- **Energy saving cold start control**

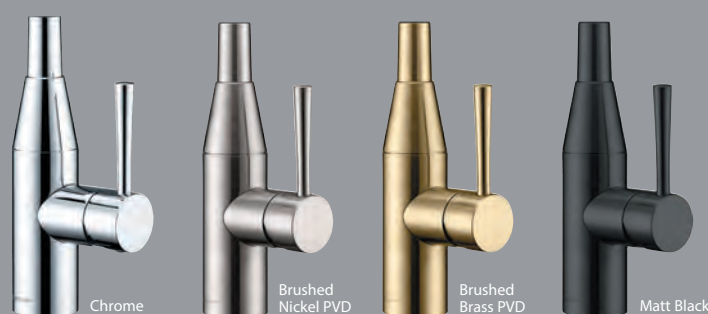



LORETO

The **Loreto's** excellent credentials belie a very economical pricing level. The minimalist design has been achieved using a 'less is more' design brief resulting in a clean and uncluttered aesthetic. The twin lever operation provides precise water and temperature control and add to the Loreto's symmetrical design. Choose from five fabulous warm and cool metal finishes including a very chic black; these elegant finishes can offer sophisticated colour coordination that truly elevate 'the look'!

Only the highest quality valves and materials are used in the Loreto construction and every tap is backed up with a full five year warranty.

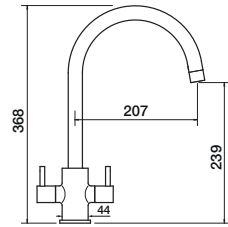

- Ref. **LOR10CP** Chrome £140
- Ref. **LOR10BN** Brushed Nickel PVD £155
- Ref. **LOR10BB** Brushed Brass PVD £155
- Ref. **LOR10BC** Brushed Copper PVD £155
- Ref. **LOR10MB** Matt Black £155

WRAS Approved



Brushed Brass PVD



Matt Black

AUVA

The **Auva** twin lever monobloc has an ultra-modern tall profile with smart high-set lever control.

Auva twin lever monobloc with 'C' swivel spout.

- Ref. **AU2CP** Chrome £198
- Ref. **AU2BN** Brushed Nickel PVD £215
- Ref. **AU2MB** Matt Black £238
- Ref. **AU2BC** Brushed Copper PVD £238
- Ref. **AU2BB** Brushed Brass PVD £238
- Ref. **AU2WH** Matt White £238

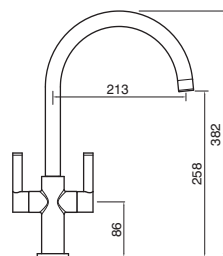

JOVIAN

The **Jovian's** beautifully simple shape lends itself for contemporary settings and can be chosen with two different spout styles.

Matching Wastes available see page 126.

See also the Jovian Professional on page 201.

Jovian single lever monobloc with 'U' swivel spout.

- Ref. **JO3CP** Chrome £160
- Ref. **JO3BN** Brushed Nickel PVD £183
- Ref. **JO3MB** Matt Black £196
- Ref. **JO3BB** Brushed Brass PVD £196
- Ref. **JO3WH** Matt White £196

Matt Black



Matt White

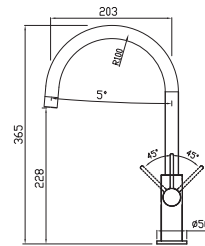

- Jovian** single lever monobloc with 'C' swivel spout.
- Ref. **JO4CP** Chrome £160
 - Ref. **JO4BN** Brushed Nickel PVD £183
 - Ref. **JO4MB** Matt Black £196
 - Ref. **JO4BB** Brushed Brass PVD £196
 - Ref. **JO4WH** Matt White £196



Icons Explained see page 131.



QUARSIL® COLOURS ELARA

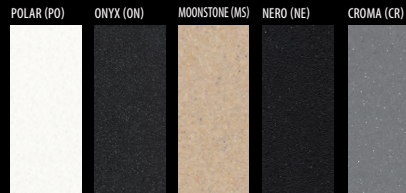

Add colour suffix when ordering

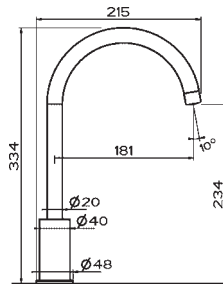

ELARA

The **Elara** is available in three metal finishes and in five Quarsil colours perfectly matched to our Quarsil granite sink collection.

- Ref. **CW02590CP** Chrome **£130**
- Ref. **CW02590BN** Brushed Nickel **£162**
- Ref. **CW02590BC** Brushed Copper **£203**
- Ref. **CW02590CP**** Chrome/Quarsil **£151**
(* add colour suffix)

WRAS Approved



MIRAM



Matching Wastes available see page 126.

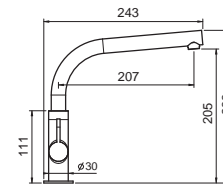
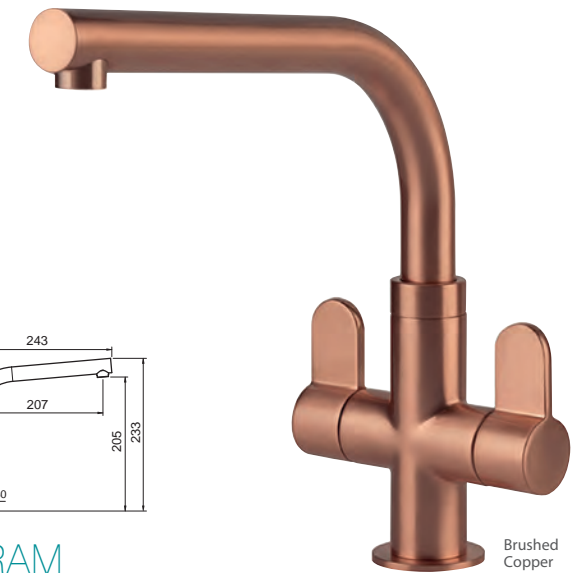

MIRAM

The **Miram** is an attractive compact tap designed to perfectly colour match Quarsil sinks, also available in an edgy brushed copper.

- Ref. **MIR2BC** Brushed Copper **£284**
- Ref. **MIR2CP**** Chrome/Quarsil **£193**
- Ref. **MIR2BN**** Brushed Nickel/Quarsil **£218**
(* add colour suffix)

WRAS Approved



TAPS MODERN QUARSIL COLOURS



Icons Explained see page 131.

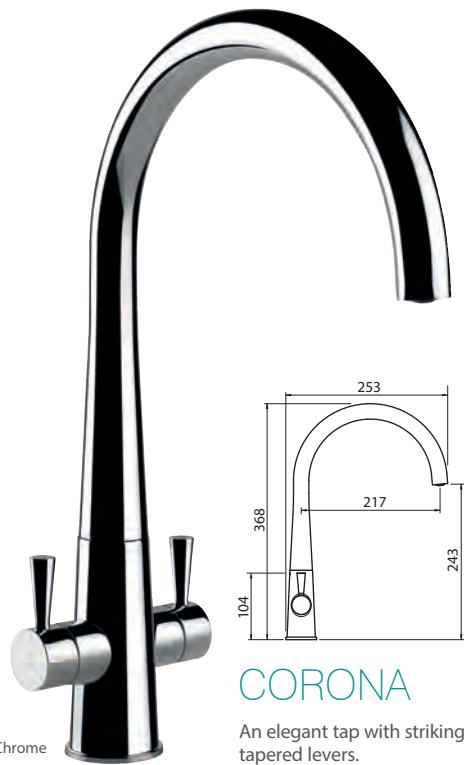

Chrome

CORONA

An elegant tap with striking tapered levers.

Ref. COR2CP
Chrome **£180**

Ref. COR2BN
Brushed Nickel **£206**



Chrome

PULSAR

The **Pulsar** is on trend with its high-set paddle controls.

Ref. PU2CP Chrome **£220**

Ref. PU2BN Brushed Nickel **£248**

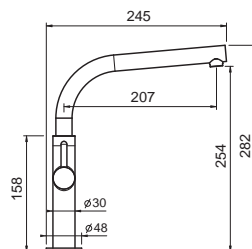

VEGAS

An understated pedestal type mixer with a restrained minimalism.

Ref. VEGCP
Chrome **£274**

WRAS Approved

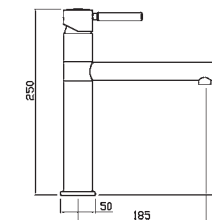

Chrome



Brushed Nickel



Icons Explained
see page 131.

SHERATAN

The **Sheratan** combines a tubular body with a rectangular spout to create very on trend tap architecture.

Ref. SH2CP Chrome **£197**

Ref. SH2BN Brushed Nickel PVD **£215**

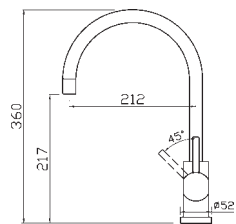
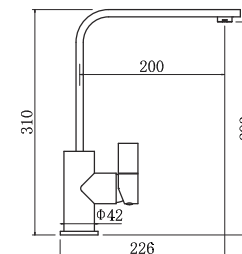

COSMO

This **Cosmo** has presence with its commanding body using a combination of round and flat surfaces - shown here in Brushed Nickel PVD finish.

Ref. COS2CP
Chrome **£137**

● Energy saving cold-start control



CHERIKA

The **Cherika's** cubist form has retro characteristics created by its subtly softened edges.

Ref. CHE2CP Chrome **£245**

Ref. CHE2BN Brushed Nickel PVD **£276**

Ref. CHE2MB Matt Black **£276**

Ref. CHE2BB Brushed Brass PVD **£276**



Brushed Brass PVD

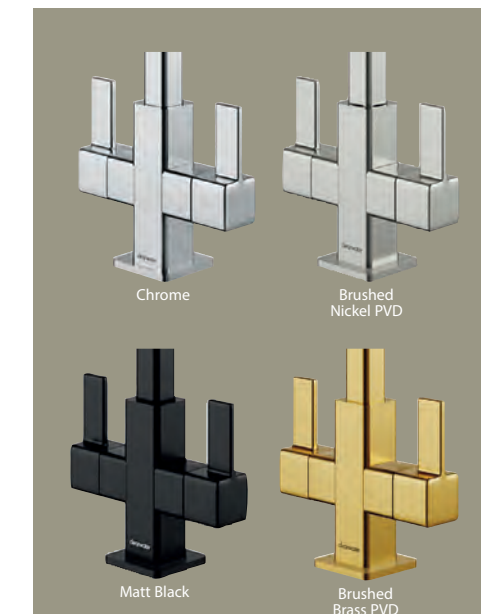

Chrome

Brushed Nickel PVD

Matt Black

Brushed Brass PVD



AURIGA

The **Auriga** has a modern slimline tubular design with a contrasting paddle lever. Also available as pull-outs - see page 239.

Ref. CW00114CP
Chrome **£174**

Ref. CW00114BN
Brushed Nickel **£209**

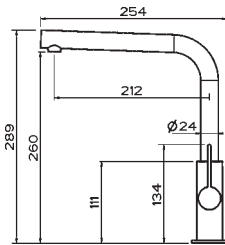

Brushed Nickel

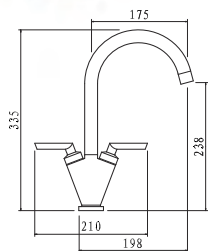
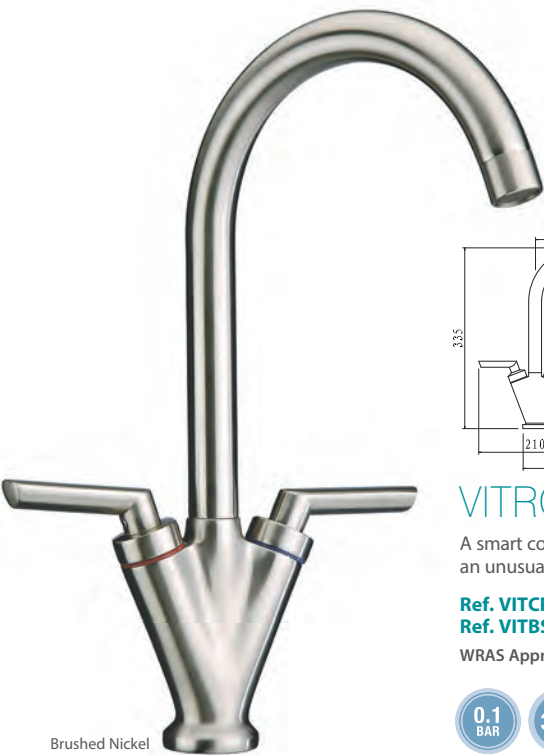

VITRO

A smart compact lever tap with an unusual 'V' shaped body.

Ref. VITCP Chrome **£132**
Ref. VITBS Brushed Nickel PVD **£142**

WRAS Approved



Brushed Nickel



ROSSI

A modern twist on the classic cross head mixer.

Ref. RO2CP Chrome **£139**
Ref. RO2BN Brushed Nickel **£175**

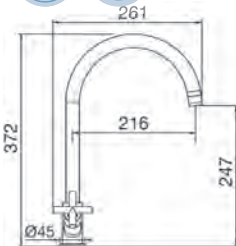

Chrome



Brushed Nickel

ULTRA

An old favourite - the original cruciform monobloc.

Ref. ULTCP Chrome **£132**
Ref. ULTBS Brushed Nickel PVD **£142**

WRAS Approved

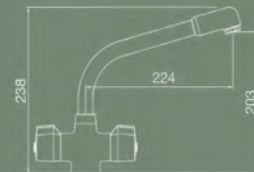

Chrome

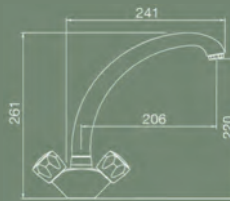

STUDIO

The **Studio** is a classic design that has proved its solid reliability for over twenty years.

Ref. STUCP Chrome **£138**

WRAS Approved

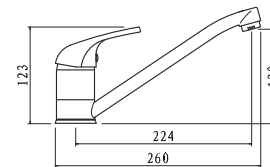

CRETA

A most popular tap at a great price, available with two flow rates; a standard flow and a water-saving regulated flow which is Sustainable Build Compliant.

Ref. 27113CP Chrome **£98**
Ref. 27113BS Brushed Nickel PVD **£113**

WRAS Approved



Chrome



Breeam Sustainable Build Compliant

Ref. 27113RCP Chrome **£123**
Ref. 27113RBS Brushed Nickel PVD **£142**
Regulated to 4 ltrs per minute

WRAS Approved

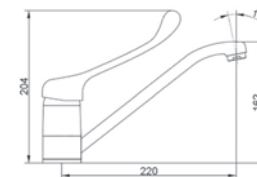

DORMAN

The **Dorman's** extra long control lever is an aid to one's reach and also helpful when hand dexterity is limited.

Ref. DORCP Chrome **£174**



Chrome



Icons Explained see page 131.



PULL-OUT

The pull-out spout is fast becoming a must-have tap for performing tasks other than simply washing-up. They are a valuable aid for rinsing down the sink after use, washing vegetables and filling large pots.

The next generation models are also available on the following pages with twin-flow spouts that can deliver standard aerated flow for filling and needle-jet spray for rinsing.



Matching Wastes available see page 126.



Levant
See the non pull-out version of the Levant tap on page 174.



Chrome

Brushed Nickel PVD

Matt Black

Brushed Brass PVD

PVD COATING
Helps to withstand surface damage and provides a more hygienic surface



Matt Black



Brushed Brass PVD

- **AERATOR**
Cascade SLC
- **EXTENSION**
Pull-out handset extends to 40cm

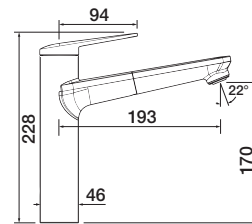

LEVANT PULL-OUT

The **Levant Pull-Out** mixer is a Swiss design masterpiece that gives a cool presence in the kitchen, it's subtly concealed pull-out spout extends its reach by 40cm for multi-tasking and smoothly retracts to transform back to its cool statuesque state.

- Ref. LEV20CP** Chrome £269
- Ref. LEV20BN** Brushed Nickel PVD £280
- Ref. LEV20MB** Matt Black £291
- Ref. LEV20BB** Brushed Brass PVD £302

WRAS Approved



Icons Explained see page 131.

Chrome

LARISSA

The **Larissa** has a very purposeful dual flow hand set with a smart sprung top section to operate the flow.

- Ref. LA2CP**
Chrome £234
- Ref. LA2BN**
Brushed Nickel PVD £254

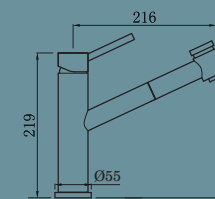

Chrome



Topaz
See the non pull-out version of the Topaz tap on page 166.



Matching Wastes available
see page 126.

PULL-OUT TOPAZ

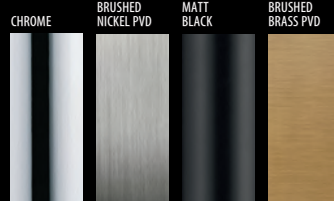

Brushed Nickel PVD

PVD COATING
Helps to withstand surface damage and provides a more hygienic surface



Brushed Nickel PVD

Matt Black

Brushed Brass PVD

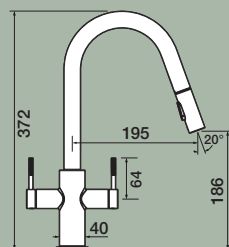

TOPAZ PULL-OUT

The slim form of the **Topaz** has a poised, ready for action stance that is very appealing. The high-set controls are a pleasure to use with their unique knurled controls, whilst the dual-flow handspray has an assured smooth pull-out movement that will multitask with ease.

Ref. TOP30BN
Brushed Nickel PVD **£302**

Ref. TOP30MB
Matt Black **£312**

Ref. TOP30BB
Brushed Brass PVD **£323**

WRAS Approved



- **TWO-FUNCTION SPRAY-HEAD**
Button allows you to switch from aerated flow to needle jet spray – ideal for rinsing down and generating detergent foam.
- **EXTENSION**
Pull-out handset extends to 60cm

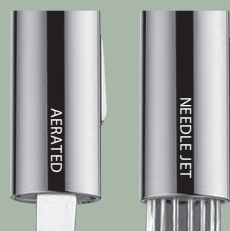

KIRA



Chrome

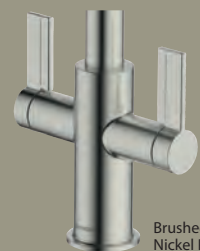

Brushed Nickel PVD



Matt Black

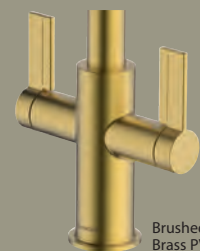

Brushed Brass PVD

- **PVD COATING**
Helps to withstand surface damage and provides a more hygienic surface
- **TWO-FUNCTION SPRAY-HEAD**
Button allows you to switch from aerated flow to needle jet spray – ideal for rinsing down and generating detergent foam.
- **EXTENSION**
Pull-out handset extends to 60cm

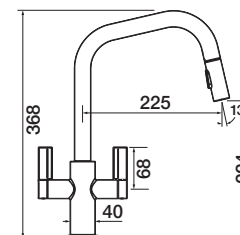

KIRA PULL-OUT

The **Kira** combines a pragmatic design with constrained minimalism. This ultra-modern tap provides easy to operate high-set controls and an indispensable pull-out handset with dual flow capability.

U Spout

Ref. KIR20CP Chrome **£269**

Ref. KIR20BN Brushed Nickel PVD **£291**

WRAS Approved

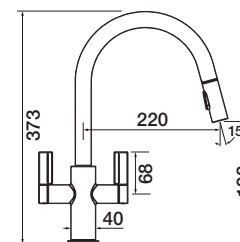

KIRA PULL-OUT

C Spout

Ref. KIR30CP Chrome **£269**

Ref. KIR30BN Brushed Nickel PVD **£291**

Ref. KIR30MB Matt Black **£312**

Ref. KIR30BB Brushed Brass PVD **£323**

WRAS Approved



Chrome



Matt Black

PULL-OUT KARUMA



SANTOR

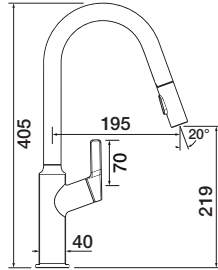

KARUMA PULL-OUT

The **Karuma's** sophisticated slimline design is complemented by the latest crank spout design. This ultra-modern mixer offers latest tech operation, including silky smooth pull-out spout with the added benefit of twin-flow options for multi-tasking.

- Ref. KAR20CP** Chrome £249
 - Ref. KAR20BN** Brushed Nickel PVD £259
 - Ref. KAR20MB** Matt Black £269
 - Ref. KAR20BB** Brushed Brass PVD £279
- WRAS Approved

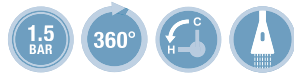

- **TWO-FUNCTION SPRAY-HEAD**
Button allows you to switch from aerated flow to needle jet spray – ideal for rinsing down and generating detergent foam.
- **EXTENSION**
Pull-out handset extends to 60cm
- **PVD COATING**
Helps to withstand surface damage and provides a more hygienic surface
- **Energy saving cold-start control**



Brushed Nickel PVD

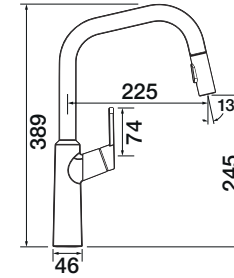

SANTOR PULL-OUT

The **Santor Pull-Out** is a great all-rounder, with smart aesthetics including a subtly tapered body and tilted ergonomic control lever. Practicality is of paramount importance and the easy pull-out hand-set offering twin flow options for multi-tasking.

- Ref. SAN20CP** Chrome £249
 - Ref. SAN20BN** Brushed Nickel PVD £259
 - Ref. SAN20MB** Matt Black £269
 - Ref. SAN20BB** Brushed Brass PVD £279
- WRAS Approved



Chrome

- **TWO-FUNCTION SPRAY-HEAD**
Button allows you to switch from aerated flow to needle jet spray – ideal for rinsing down and generating detergent foam.
- **EXTENSION**
Pull-out handset extends to 60cm
- **Energy saving cold-start control**

Matching Wastes available see page 126.



Chrome

Brushed Nickel PVD

Matt Black

Brushed Brass PVD



Chrome

Brushed Nickel PVD

Matt Black

Brushed Brass PVD

PVD COATING
Helps to withstand surface damage and provides a more hygienic surface



Pioneer
See the non pull-out version of the Pioneer tap on page 173.



Matching Wastes available
see page 126

PULL-OUT PIONEER

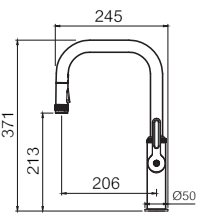
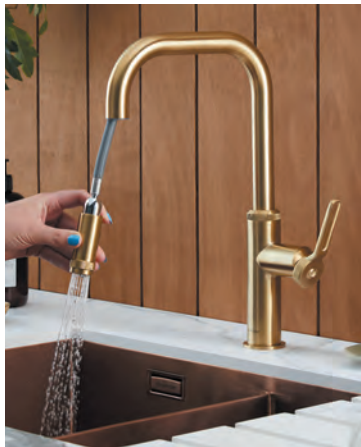
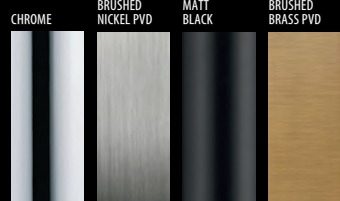

PIONEER PULL-OUT

The design of the **Pioneer Pull-Out** has been inspired by the aesthetics of our industrial past with its use of knurled components and steam valve style lever. The pull-out spout adds to this tap's versatility with its switch controlled flow options providing aerated water for filling and needle jet spray for rinsing.

- Ref. PIL40CP** Chrome £356
- Ref. PIL40BN** Brushed Nickel PVD £377
- Ref. PIL40MB** Matt Black £389
- Ref. PIL40BB** Brushed Brass PVD £399

WRAS Approved



- **PVD COATING**
Helps to withstand surface damage and provides a more hygienic surface
- **Energy saving cold-start control**



Brushed Brass PVD

CRETA PULL-OUT

The **Creta Pull-Out** is a great all rounder with a simple to use hand spray with twin spray modes - changeable at the press of a button.

- Ref. CREPOCP** Chrome £242
- Ref. CREPOBN** Brushed Nickel £293

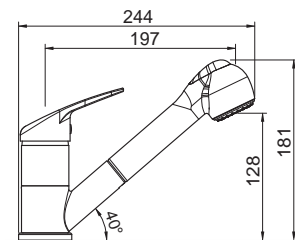

Chrome



Icons Explained
see page 131.



PORRIMA PULL-OUT

The **Porrima** possesses a gently fluted shape making it slightly less stern than the usual sheer minimalist styling.

- Ref. PO3CP** Chrome £327
- Ref. PO3BN** Brushed Nickel PVD £376

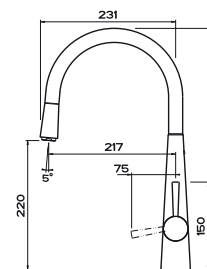

Chrome

PULL-OUT

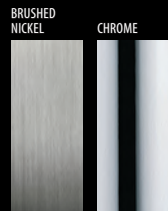

EMPORIA

The **Emporia** has a pragmatic down to earth presence and is an old favourite that just keeps delivering.

Ref. EMPCP
Chrome **£328**

Ref. EMPBS
Brushed Nickel **£366**

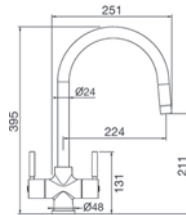

CLASSIC STYLES



ELMIRA

A crisply sculptured mixer with the added benefit of a pull-out aerator.

Ref. ELMCP Chrome **£344**

Ref. ELMBS Brushed Nickel **£392**

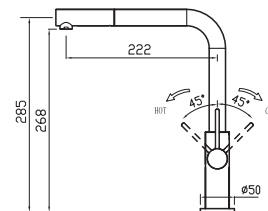
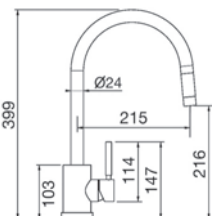

Ref. AUR2CP Chrome/White **£190**

Ref. AUR2BN
Brushed Nickel PVD/White **£216**

Ref. AUR3CP Chrome/Black **£190**

Ref. AUR3BN
Brushed Nickel PVD/Black **£216**



AURIGA

A slimline family of taps available in all metal finishes or supplied with a choice of hardwearing coloured spouts – perfect for coordinating with door fronts and appliances.

COLOURS

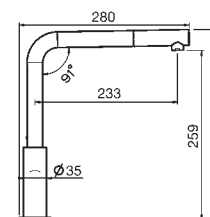
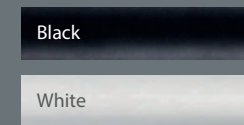

Ref. CW00214CP Chrome **£230**

Ref. CW00214BN Brushed Nickel **£259**



Icons Explained see page 131.



PROFESSIONAL



This shining star of the kitchen is an impressive centre piece that can multi-task with expertise. The professional style spout swivels on its holder and can be detached and directed for close work, with most models having dual flow handsets that can deliver a standard aerated flow for filling and needle-jet spray for rinsing.



Chrome



Brushed Nickel PVD



Matt Black



Brushed Brass PVD



Chrome

TAPS MODERN PROFESSIONAL



Brushed Brass

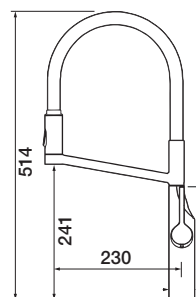

ALASIA PRO

The **Alasia Pro** is the latest generation of semi-professional taps. The tall architectural body has subtle design elements that blend perfectly together with an easy-maintenance silicon spout that can swivel and pull-down for food prep and the detachable hand-set offers twin flow options at the press of a button.

The handset can be positioned with the button at the front or back, whichever is more comfortable.

- Ref. **ALA30CP** Chrome £269
- Ref. **ALA30BN** Brushed Nickel PVD £279
- Ref. **ALA30MB** Matt Black £289
- Ref. **ALA30BB** Brushed Brass PVD £299

WRAS Approved



- DETACHABLE TWO-FUNCTION SPRAY HEAD Aerator & Cascade
- EASY-DOCK SPRAY HEAD
- EASY CLEAN SPRAY JETS
- COLD START
- PVD COATING Helps to with-stand surface damage and provides a more hygienic surface

Matching Wastes available see page 126.

Icons Explained see page 131.

PROFESSIONAL GALAXY

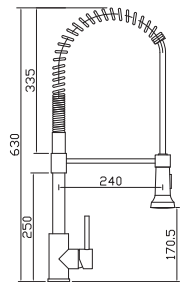
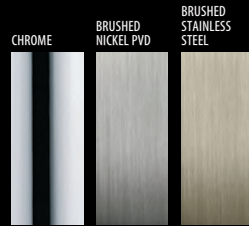

GALAXY

The **Galaxy** is constructed from solid 304 grade stainless steel and is a full scale professional tap providing great reach with its dual flow handset.

Ref. GAX2SS
Stainless Steel £384

- Energy saving cold-start control



Stainless Steel

TUTTI PRO

The **Tutti Pro** is a twin lever design with a flexible steel sprung coil to maximise the spout range, it also comes equipped with a chef's dual flow handset.

Ref. TP2CP Chrome £306

Ref. TP2BN Brushed Nickel PVD £327

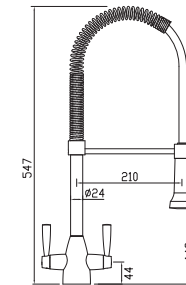

Chrome



Brushed Nickel PVD

TRITON

The **Triton** offers all the professional tap attributes - detachable dual flow handset and pull-out sprung steel coil for greater flexibility.

Ref. TR2CP
Chrome £265

Ref. TR2BN
Brushed Nickel PVD £305

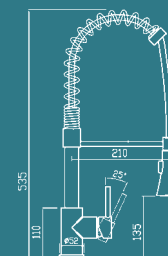

Brushed Nickel PVD



Chrome

PROFESSIONAL MERIDIAN

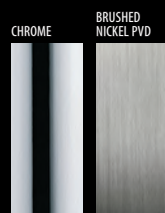

The **Meridian** is a semi-professional mixer with easy-clean silicon spouts that feature twin flow aerators. The spouts are ideal for colour coordinating with hob and appliances and can be detached from their swivel-holder when a longer reach is required.

HOSE COLOURS

- Black MEBT £23
- White MEWT £23
- Grey MEGT £23
- Red MERT £23

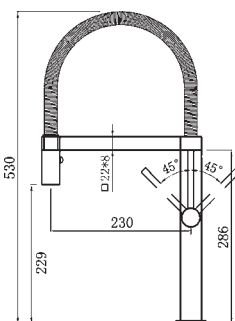

White & Chrome



Meridian single lever monobloc with detachable white silicon swivel spout with dual-flow spray.
Ref. ME2CP
 Chrome/White £303
Ref. ME2BN
 Brushed Nickel PVD/White £347



White & Brushed Nickel PVD



Meridian single lever monobloc with detachable black silicon swivel spout with dual-flow spray.
Ref. ME3CP
 Chrome/Black £303
Ref. ME3BN
 Brushed Nickel PVD/Black £347



Black & Chrome



See also the Standard Jovian taps on page 179.

JOVIAN

The **Jovian** boasts modern slimline construction with a close sprung coil and detachable dual flow handset with integrated flow switch.

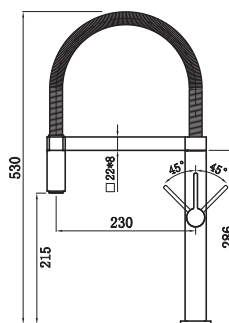

Jovian single lever monobloc with spring swivel spout detachable dual flow handset with integrated flow switch.
Ref. JO2CP Chrome £303



Chrome



Icons Explained see page 131.

STAINLESS STEEL

Stainless steel taps are becoming more and more popular with very good reason. They are the perfect match with stainless steel sinks and appliances and they are highly resilient to wear and tear whilst retaining their lustrous good-looks for years.

BRUSHED STAINLESS STEEL



SINGLE LEVER

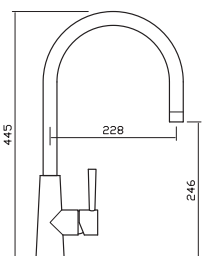

Titania
Ref. T12SS Stainless Steel £222



Titania Pull-out
Ref. T13SS Stainless Steel £402

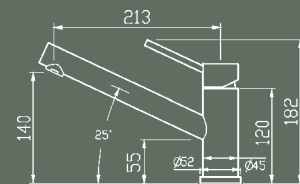
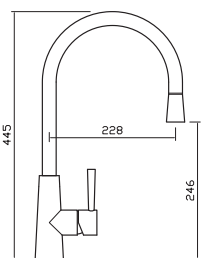

Sirius
Ref. S12SS Stainless Steel £217



SIRIUS

The classic simple tube design of the **Sirius** offers cool minimalism in the kitchen and looks great when paired with granite and under-mount bowls. These iconic designs are available in standard or pull-out spouts.



Sirius Pull-out
Ref. S13SS Stainless Steel £278
REG4 Approved

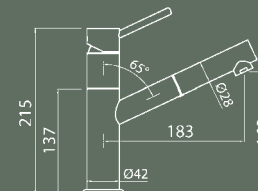

TITANIA

The tall slender shape of the **Titania** mixers make a dynamic statement with their elegant tapering design and truly represent the next generation of minimalist styling.



STAINLESS STEEL SINGLE LEVER

The universal Single Lever remains a popular choice for adding a continental style to the kitchen.

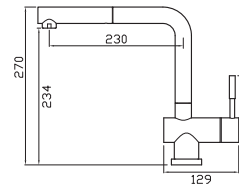

MERCURY

A smooth L shaped tap with a pull-out aerator.

Ref. **MER2SS** Stainless Steel £282

- Energy saving cold-start control

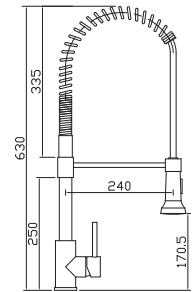

GALAXY

The **Galaxy** is constructed from solid 304 grade stainless steel and is a full scale professional tap providing great reach with its dual flow handset.

Ref. **GAX2SS** Stainless Steel £384

- Energy saving cold-start control



COLD WATER SIPHON

This compact cold water tap is a perfect solution to install with a secondary sink to create an entertainment area.

Please note there is also a filtered water version of this tap available in our Filter section, see page 158.

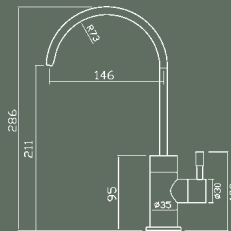

MIRA

Ref. **MI2SSC** Stainless Steel £138



STAINLESS STEEL TWIN LEVER

The Twin Lever taps work well with both low and high pressure systems and the separate controls are the most simple to operate.



CALYPSO

A stylish duo with elegant twin levers.

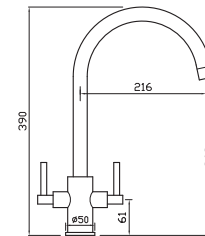

Ref. **CAL2SS** Stainless Steel £278
REG4 Approved

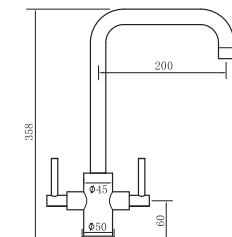
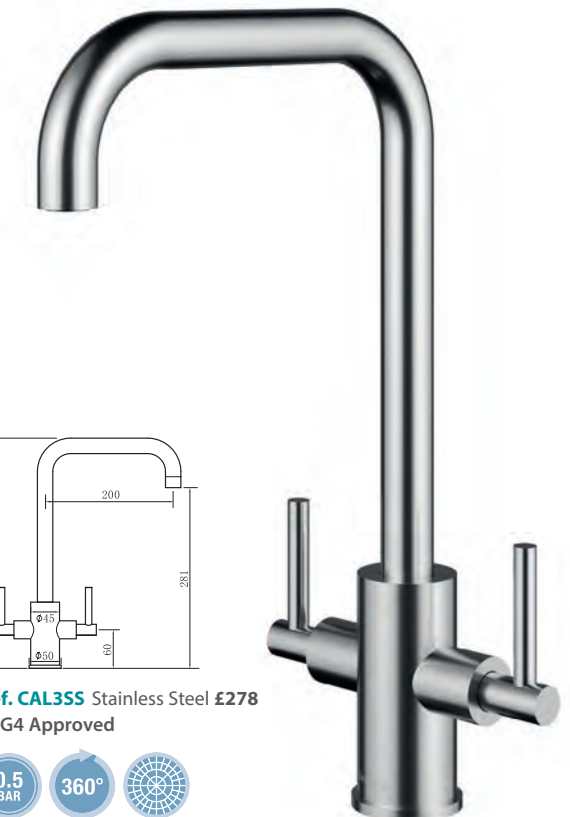

Ref. **CAL3SS** Stainless Steel £278
REG4 Approved



PULL-OUT SPRAY MODERN



Spray Controls

PULL-OUT SPRAY TRADITIONAL



Needle Jet Spray



Aerated Spray



Chrome



Brushed Nickel PVD



Brushed Brass PVD



Needle Jet Spray

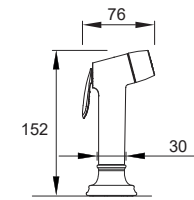

Traditional Pull-Out Spray
Ref. TP10CP Chrome £115
Ref. TP10BN Brushed Nickel £130
Ref. TP10BB Brushed Brass £140
Ref. TP10BC Brushed Copper £135
Ref. TP10BZ Brushed Bronze £145
 Min Pressure 0.7 Bar
 Mounting Hole Size Ø35mm



Chrome



Brushed Nickel PVD



Brushed Brass PVD



Brushed Copper PVD



Brushed Bronze PVD



Matt Black



Stainless Steel

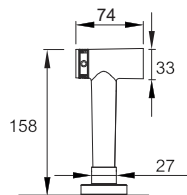

Modern Pull-Out Spray
Ref. MP10CP Chrome £105
Ref. MP10BN Brushed Nickel £120
Ref. MP10BB Brushed Brass £130
Ref. MP10MB Matt Black £125
Ref. MP10SS Stainless Steel £125
 Min Pressure 0.7 Bar
 Mounting Hole Size Ø35mm



Aerated Spray

The **Pull-Out Spray** is an incredibly useful tool for all manner of jobs, from rinsing off crockery prior to the dishwasher, rinsing veg and salads and cleaning down the sink.

Once you have one you will never be without one again!

They make a particularly valuable kitchen aid when partnered with non-pull out and professional taps when there is no facility for a directable flow.

There are two flow types at cold mains pressure:

Aerated - ideal for vessel filling and gentle rinsing of delicate food.

Needle-Jet - for rinsing the crockery prior to dishwasher, food preparation - washing salads and rice etc and rinsing around the sink bowl and drainer after use.

- 60cm working range with auto-retract hose
- Twin flow types: Aerated, Needle-Jet
- Auto lock for hands-free operation
- Mains pressure cold flow – variably controlled
- Five finishes perfectly matched with the Clearwater modern and traditional ranges

PULL-OUT SPRAYS MODERN & TRADITIONAL

TRADITIONAL

These traditional models are a nostalgic collection of high quality reproduction period taps. All these taps combine their historical aesthetics with the modern technology used with their Modern cousins. Each tap is available in a choice of finishes as illustrated on these pages.



Matching Wastes available see page 126.



TWIST & SPRAY®

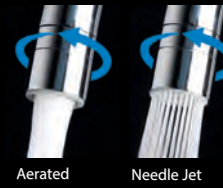

ELEGANCE

- Ref. EL20CP Chrome £219
- Ref. EL20BN Brushed Nickel PVD £229
- Ref. EL20BZ Brushed Bronze PVD £259
- Ref. EL20BC Brushed Copper PVD £239
- Ref. EL20BB Brushed Brass PVD £249

WRAS Approved
Quarter turn ceramic disc valves

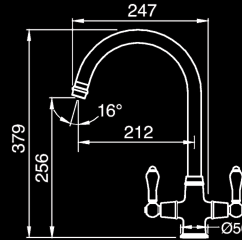

Brushed Nickel PVD



Icons Explained see page 131.

EQUINOX

The Equinox boasts pleasingly soft styling that works perfectly with more contemporary design ceramic sinks.



Antique Brass

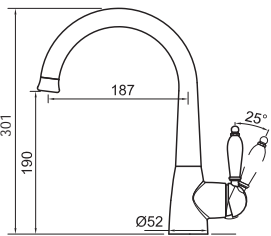

- Ref. EQ5CP Chrome £253
- Ref. EQ7BN Brushed Nickel £292
- Ref. EQ6G Gold £328
- Ref. EQ8AB Antique Brass £339

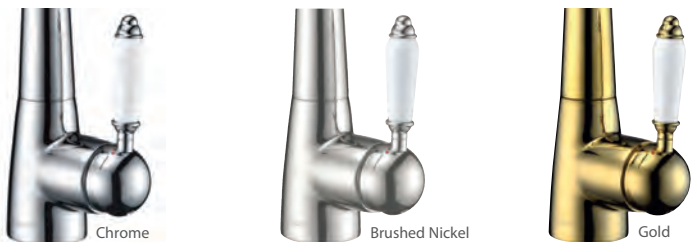

Chrome

Brushed Nickel

Gold

ELEGANCE

The Elegance taps truly reflect our elegant past with ceramic control levers and tall swan neck spouts. The monobloc style is a popular choice with ceramic inset sinks whilst the Bridge model works perfectly with Apron front Belfast models. The spout incorporates a Twist & Spray Aerator to suit multiple kitchen chores.

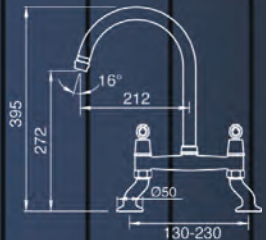

ELEGANCE BRIDGE

- Ref. ELB10CP Chrome £239
- Ref. ELB10BN Brushed Nickel PVD £249
- Ref. ELB10BZ Brushed Bronze PVD £289
- Ref. ELB10BC Brushed Copper PVD £269
- Ref. ELB10BB Brushed Brass PVD £279

WRAS Approved
Quarter turn ceramic disc valves



Brushed Bronze PVD

209

TRADITIONAL

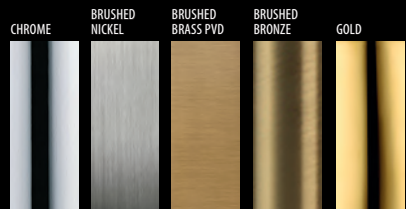

Brushed Nickel

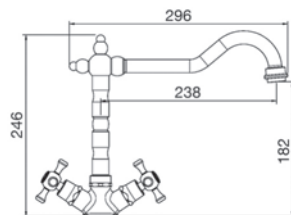

BAROC

- Ref. BAC Chrome £250
- Ref. BAN Brushed Nickel £285
- Ref. BAB Brushed Bronze £285
- Ref. BABR Brushed Brass £318

Full turn compression valves

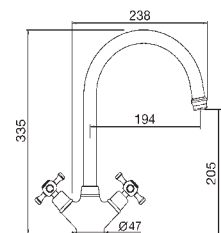

COTTAGE

- Ref. COTC Chrome £242
- Ref. COTN Brushed Nickel £311
- Ref. COTG Gold £311
- Ref. COTB Brushed Bronze £311
- Ref. COTBR Brushed Brass £311

Full turn compression valves
WRAS Approved



Chrome

COTTAGE

The **Cottage** taps are a nostalgic family of taps with crosshead controls with ceramic indices. As with all of our traditional taps they are ideally matched with traditional ceramic sinks to complete the country farmhouse or retro theme.



Matching Wastes available
see page 126.

BAROC

The **Baroc's** exuberant styling echo the distinctive styles of the Baroque period and are perfect partner with traditional style ceramic sinks. As with most of our traditional collection there are many metal finishes to choose from and don't forget wastes can be colour matched with the taps.



Brushed Bronze

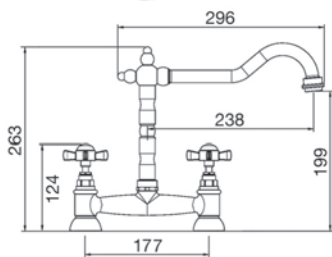

BAROC BRIDGE

- Ref. BBC Chrome £320
- Ref. BBN Brushed Nickel £354
- Ref. BBB Brushed Bronze £354
- Ref. BBBR Brushed Brass £402

Full turn compression valves



Brushed Nickel

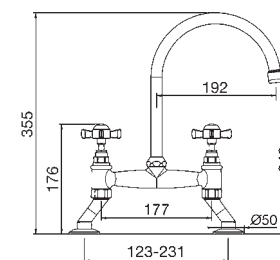

COTTAGE BRIDGE

- Ref. COTBC Chrome £361
- Ref. COTBN Brushed Nickel £450
- Ref. COTBG Gold £450
- Ref. COTBB Brushed Bronze £450
- Ref. COTBBR Brushed Brass £450

Full turn compression valves



Icons Explained
see page 131.



Matching Wastes available see page 126.

TRADITIONAL

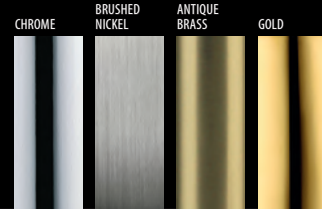

Chrome

Chrome

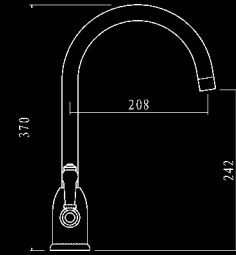

DEPHINI

Ref. DE2CP Chrome £209

Ref. DE2BN Brushed Nickel PVD £229



DEPHINI

The Dephini twin lever monobloc is based on a traditional design but with a modern twist, whilst the Bridge strictly follows a nostalgic format with scrolling on the valve covers and the spout. Note with the Bridge mixer the levers face forward when in the off position.

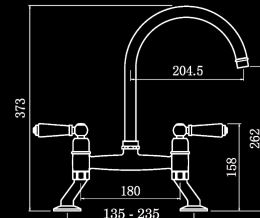

DEPHINI BRIDGE

Ref. DE3CP Chrome £244

Ref. DE3BN Brushed Nickel PVD £263

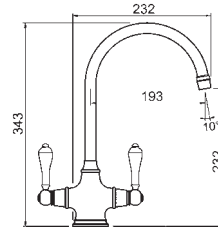

ALRISHA

The Alrisha's flamboyant scroll detailing add a luxurious extravagance to this elegant neo-Victorian design.

Ref. ALR2CP Chrome £350

Ref. ALR2BN Brushed Nickel £375

Ref. ALR2BZ Brushed Bronze £415

Ref. ALR2BC Brushed Copper £423

Ref. ALR2BB Brushed Brass £423



Brushed Bronze

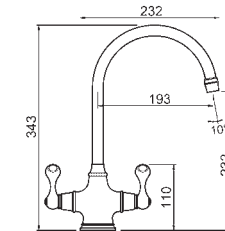

CORIOLIS

The Coriolis shares the same fine scroll detail as the Alrisha but differs with its rather intriguing forward facing ceramic indices denoting the water temperature.

Ref. CO2CP Chrome £331

Ref. CO2BN Brushed Nickel £358

Ref. CO2BZ Brushed Bronze £364

Ref. CO2BC Brushed Copper £385

Ref. CO2BB Brushed Brass £394



Brushed Copper

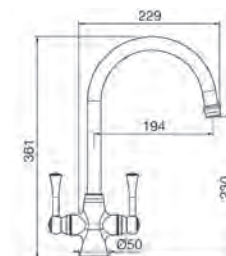

REGENT

The Regent straddles contemporary and traditional styling with its soft curves and ceramic detailing.

Ref. LANCP Chrome £236

Ref. LANBN Brushed Nickel £299

Ref. LANBZ Brushed Bronze £280

Ref. LANBB Brushed Brass £324



Brushed Nickel



Icons Explained see page 131.

PRODUCTS FOR CARE AND CLEANING

We have an amazing range of sinks and taps and always recommend that they are cleaned and cared for to keep their charm and beauty the same as the day they were installed.

CARE OF SINKS



GRANITE

**Clearwater
Granite Care Set**
Ref. CLEG100 £40

Comprising of -
an alcohol based cleaner
a brightener and a
nano sponge



CERAMIC & CAST IRON

**Clearwater
Cast Iron and
Ceramic Cleaner**
Ref. CLEC200 £14

Removes stubborn metal
marks and stains with little
effort



STAINLESS

HG - Stainless Polish
Ref. 168030106 £6

Designed for maintenance of
Stainless Steel, leaving a great
shine and streak free, great for
combating really tough
blemishes.

250ml



CERAMIC & STAINLESS

Cramer - Email Star
Ref. 30100 £14

Sensitive, acid free cleaning
and care of Ceramic, Enamel
and Stainless surfaces.

100ml

CARE OF TAPS



POLISHING

Cramer - Chrom Star
Ref. 30150 £14

Gentle cleaning and polishing
compound for all chrome
surfaces.

100ml

FOR DAMAGES TO ENAMEL & CERAMIC



**Cramer - Bath & Kitchen
Rubber**
Ref. 30303 £14

Removes scuff marks, rust and
heavy soiling on Enamel and
Ceramic without scratching.



Cramer - Repair Kit
Ref. 16XXX £36

For minor damage and chips
to Ceramic, Enamel & Acrylic.
For an easy and durable
repair.

● Postage and packaging charges may be incurred. ● Cleaning products can either be ordered from the retailer or direct from us.